

Quartz Crystal

SMD-version

part no.	12.89006
model	KX – 9A
frequency	10.0 MHz
mode	fundamental
operating temperature	-20° ~ +70°C
frequency tolerance at +25°C	±30 ppm
temperature tolerance -20° ~ +70°C	±50 ppm
load capacitance C_L	16 pF
series resistance R1 max.	100 Ohm
aging at 25°C (first year) max.	±2 ppm
shunt capacitance C_O max.	5.0 pF
drive level max.	300 μ W
contents of reel	1000 pcs.

Dimensions (mm):

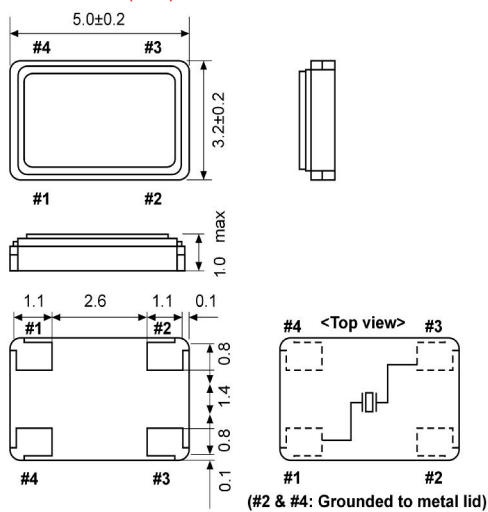

Suggested soldering pad:

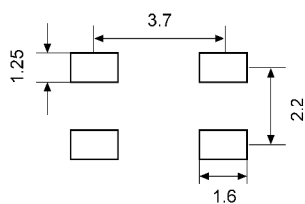

Reflow soldering condition:

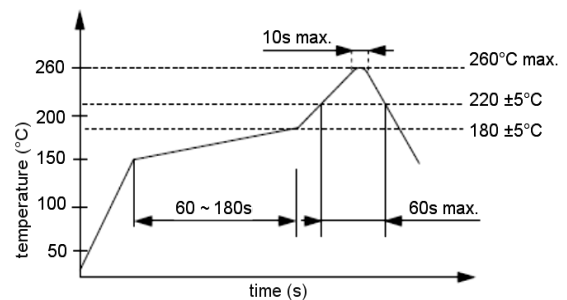

Tape specification:

