

# Autonics

## PHOTOELECTRIC SENSOR BJ SERIES

### M A N U A L



Thank you very much for selecting Autonics products.  
For your safety, please read the following before using.

### Caution for your safety

- Please keep these instructions and review them before using this unit.
- Please observe the cautions that follow;
  - Warning** Serious injury may result if instructions are not followed.
  - Caution** Product may be damaged, or injury may result if instructions are not followed.
- The following is an explanation of the symbols used in the operation manual.
  - Injury or danger may occur under special conditions.

### Warning

- In case of using this unit with machinery which need safety control (Ex:Nuclear power control, medical equipment, vehicle, train, airplane combustion apparatus, entertainment or safety device etc), it requires installing fail-safe device, or contact us for information on type required. It may cause a fire, human injury or damage to property.
- Do not disassemble or modify this unit. Please contact us if it is required. It may give an electric shock and cause a fire.

### Caution

- This unit shall not be used outdoors. It might shorten the life cycle of the product or give an electric shock.
- Do not use this unit in place where there is flammable or explosive gas. It may cause a fire or explosion.
- Please observe the rated specifications. It may shorten the life cycle or damage to the product.
- Do not use this unit beyond rating power and do not supply AC power at DC power type. It may result in damage to this unit.
- Please check the polarity of power and wrong wiring. It may result in damage to this unit.
- Do not use this unit in place where there is vibration or impact. It may result in damage to this unit.
- In cleaning the unit, do not use water or an oil-based detergent. It might cause an electric shock or fire that will result in damage to the product.

### Ordering information

BJ 15 M - T D T 1 - P	
Output type	NPN open collector output
P	PNP open collector output
Single body type	
1	Emitter
2	Receiver
Output mode	T Solid-state output (TR)
D	DC power
Sensing type	T Through - beam
P	Polarized retroreflective
D	Diffuse Reflective
Sensing distance unit	mm
M	m
Sensing distance	Number Sensing distance
Item	BJ Compact long sensing type

\*The above specifications are subject to change without notice.

### Specifications

Model	BJ15M-TDT	BJ10M-TDT	BJ7M-TDT	BJ3M-PDT	BJ1M-DDT	BJ300-DDT	BJ100-DDT	
NPN output	BJ15M-TDT-P	BJ10M-TDT-P	BJ7M-TDT-P	BJ3M-PDT-P	BJ1M-DDT-P	BJ300-DDT-P	BJ100-DDT-P	
PNP output								
Sensing type	Through - beam			Polarized Retroreflective				
Sensing distance	0-15m	0-10m	0-7m	0.1-3m (MS-2A) (#1)	1m (Non-glossy white paper 300x300mm)	300mm (Non-glossy white paper 100x100mm)	100mm (Non-glossy white paper 100x100mm)	
Sensing target	Opaque materials of Min. φ12mm		Opaque materials of Min. φ8mm	Opaque materials of Min. φ75mm	Translucent, Opaque materials			
Hysteresis				Max. 20% at sensing distance				
Response time	Max. 1ms							
Power supply	12-24VDC ±10% (Ripple P-P: Max. 10%)							
Power consumption	Emitter: Max. 20mA Receiver: Max. 20mA			Max. 30mA				
Light source / Wavelength	Infrared LED (850nm)	Red LED (660nm)	Red LED (Point light source 650nm)	Red LED (660nm)	Infrared LED (850nm)	Red LED (660nm)	Infrared LED (850nm)	
Sensitivity adjustment	Built-in VR							
Operation mode	Light ON/Dark ON Selectable							
Control output	NPN or PNP Open collector type • Load voltage: Max. 26.4VDC • Load current: Max. 100mA • Residual voltage: NPN: Max. 1V, PNP: Min. (Power voltage -2.5V)							
Protection circuit	Reverse polarity protection circuit, Output short-circuit(overcurrent) protection circuit			Reverse polarity protection circuit, Interference prevention function, Output short-circuit(overcurrent) protection circuit				
Indicator	Operation indicator:Red, Stability indicator:Green (Emitter of power indicator for transmitted beam:Green)							
Connection	Outgoing cable							
Insulation resistance	Min. 20MΩ (500VDC megger)							
Noise strength	±240V the square wave noise(pulse width:1μs) by the noise simulator							
Dielectric strength	1,000VAC 50/60Hz for 1minute							
Vibration	1.5mm or 300m/s <sup>2</sup> amplitude at frequency of 10-55Hz(for 1min.) in each X, Y, Z direction for 2 hours							
Shock	500m/s <sup>2</sup> in X, Y, Z directions for 3 times							
Ambient illumination	Sunlight: Max. 11,000lx, Incandescent lamp: Max. 3,000lx (Receiver illumination)							
Ambient Temperature	Operation: -25 ~ 55°C, Storage: -40 ~ 70°C (at non-freezing, at non-dew status)							
Ambient humidity	Operation & Storage: 35-85%RH (at non-dew status)							
Protection	IP65(IEC standards)							
Material	Case: PC+ABS, LED CAP: PC, Lens: PMMA							
Cable	φ3.5mm, 3P, Length: 2m (Emitter: φ3.5mm, 2P, Length: 2m) 22AWG, Core wire diameter: 0.08mm, No. of core wire: 60							
Accessories	Common	Mounting bracket, Bolt, Nut, VR adjustment driver					Individual	Reflector (MS-2A)
Approval	CE							
Unit weight	Approx. 90g			Approx. 60g		Approx. 45g		

\*1: If reflector MS-2S, MS-3S(Sold separately) are used, sensing distance will be lengthened as 0.1-4m, 0.1-5m.

### Dimensions

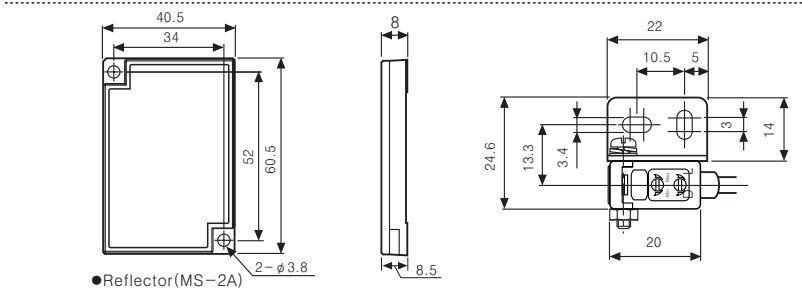
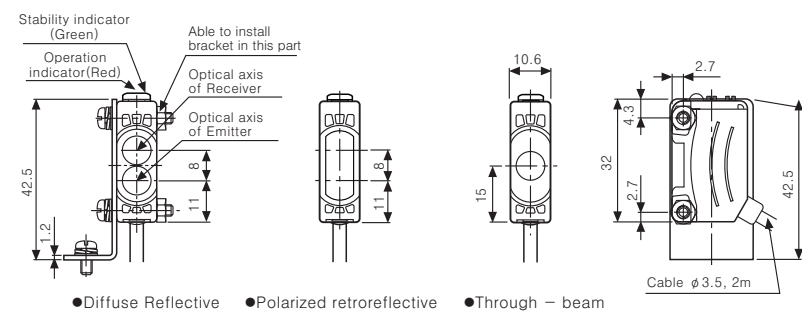

### Connections

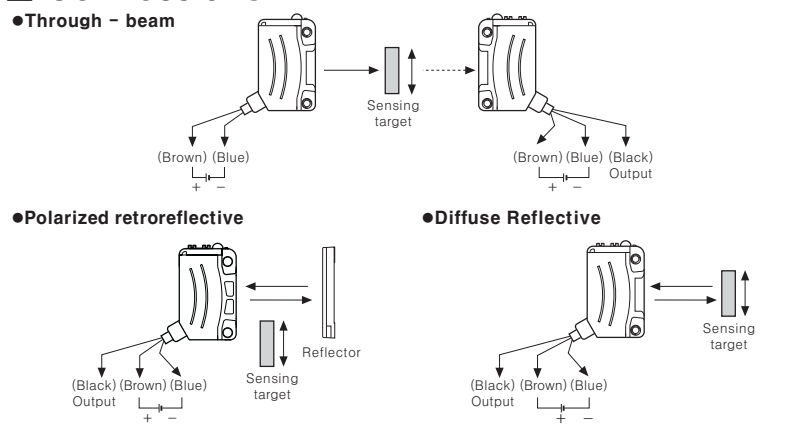

### Control output circuit diagram

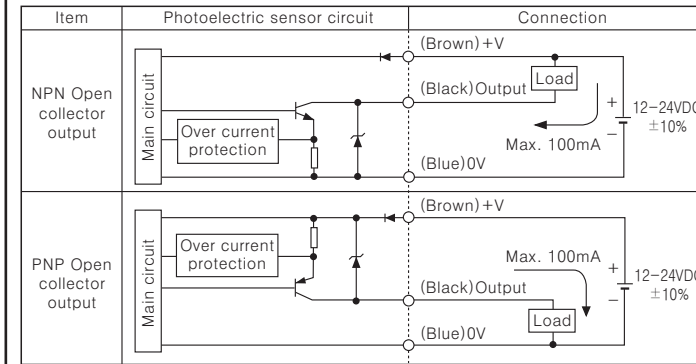

### Mounting & Adjustment

- For mounting**  
Please use bolt M3 for mounting of sensor, set the tightening torque under 0.5N.m.
- Switching operation mode**  
Light ON operation mode (Light ON): Turn the switching volume of operation mode to the end of right(L direction), it is set as Light ON mode.  
Dark ON operation mode (Dark ON): Turn the switching volume of operation mode to the end of left (D direction), it is set as Dark ON mode.

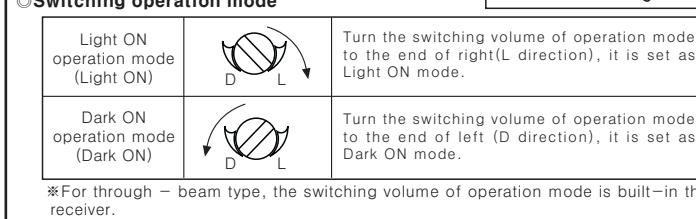

\*For through - beam type, the switching volume of operation mode is built-in the receiver.

### Optical axis adjustment

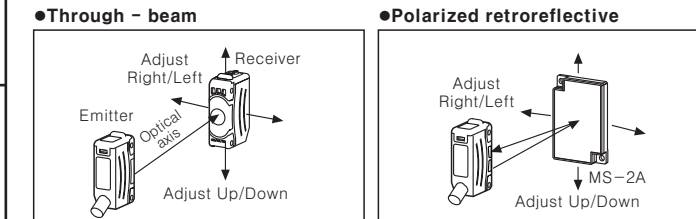

- Supply the power after setting the emitter and the receiver in opposite side other.
- Check the stable indicator operation range with moving or rotating the position of sensor and mirror as right/left and up/down minutely and mount it in the middle of it.
- After mounting, check the normal operation of sensor and lighting of stable indicator with sensing target or without it.

\*If the sensing target is translucent body or smaller than φ12mm, it may not sense the target because light is passed.

### Sensitivity adjustment

Order	Sensitivity adjuster	Description
1	(A) MIN MAX	Turn the sensitivity adjuster to the right from min. sensitivity position and check(A) where the indicator is turned on in "Light ON status".
2	(A) MIN MAX (B) (C)	Turn the sensitivity adjuster more to the right from min. sensitivity position, check(B) where the indicator is turned on and turn the adjuster to the left, check(C) where the indicator is turned off in "Dark ON status". *If the indicator is not lighted although the adjuster is turned to the max. position, the max. position is(C).
3	(A) MIN MAX (C)	Set the adjuster at the center of (A) and (C). Also setting of the optimum sensitivity, check the operation is correct and lighting of stable indicator with sensing target or without it. If the indicator is not lighted, please check the sensing method again because sensitivity is unstable.

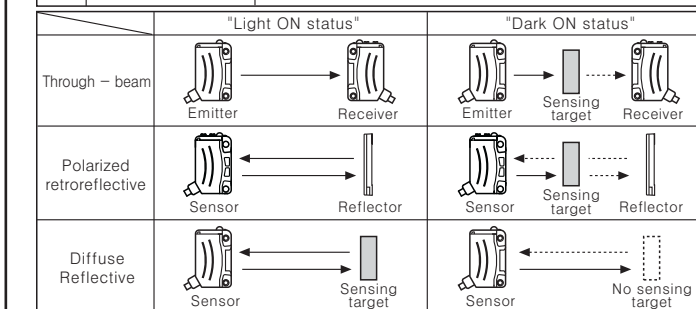

\*Please set adjuster as sensitivity adjustment is executed in stable Light ON area and the reliability of environment(temperature, supply, dust etc.) is increased after the mounting it in a stable area.  
\*It may cause breakdown when the sensitivity and operation mode conversion adjuster is turned by force.

### Operation mode

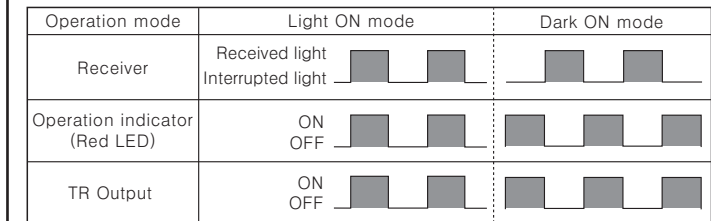

### Operation timing diagram

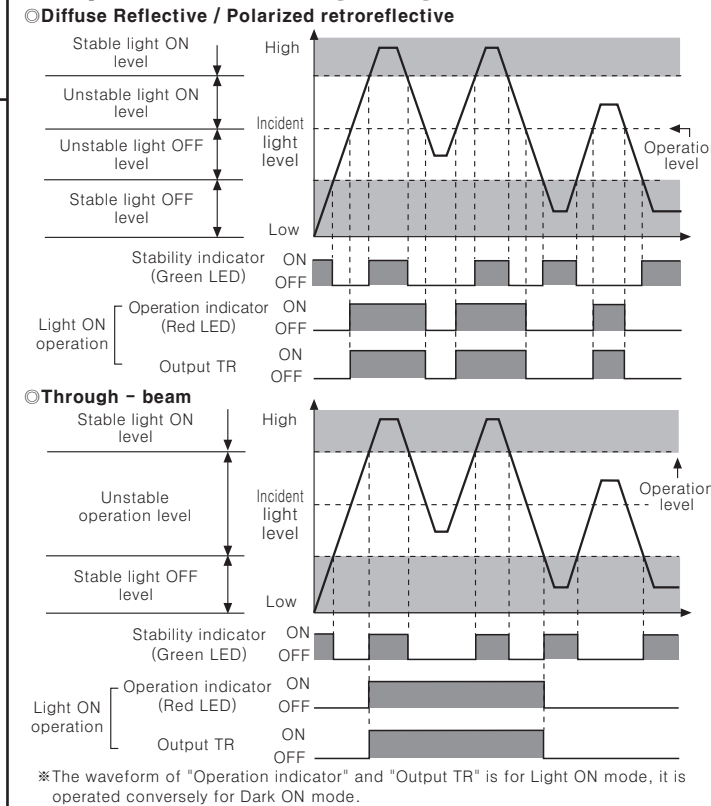

### Caution for using

- The sensor will be in a detectable status within 500ms after supply the power. If the power line of the load and the sensor is different, supply power voltage to the sensor first.
- Shade a strong source of light as like sunlight, spotlight not to be let in the inclination angle range of photoelectric sensor directly.
- The photoelectric sensor may cause malfunction under the fluorescent lamp light, be sure to use the cover or the shutter to shade the light.
- When more than 2 sets of through - beam types sensors are used closely, it might cause interference each other. Be sure to put enough space between them in order to avoid malfunction.
- If photoelectric sensor is installed at flat part, it may cause malfunction by reflection light from flat part. Be sure to put space between photoelectric sensor and ground.
- When wiring the photoelectric sensor with high voltage line, power line in a same conduit, it may cause malfunction or mechanical problem, please do wire separately or use different conduit.
- Avoid install the unit in place with corrosive gas, oil or dust, strong flux, noise, sunlight, strong alkali and acid.
- In case of connecting relay as inductive load to output, please remove surge by using diode or varistor.
- Photoelectric sensor cable shall be used as short as possible, because it may cause malfunction by noise through the cable.
- When it is stained by dirt at lens, please clean the lens with dry cloth, do not use an organic materials such as alkali, acid and chromic acid.
- When using switching power supply as the source of supplying power, F.G terminal shall be grounded and a condenser for removing noise shall be installed between 0V and F.G terminal.

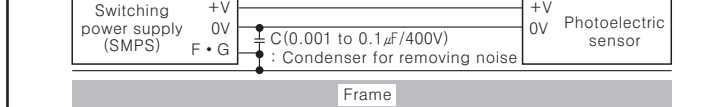

\*It may cause malfunction if above instructions are not followed.

### Major products

- Proximity sensors
- Area sensors
- Door/Door side sensors
- Counters
- Rotary encoders
- Power controllers
- Panel meters
- Temperature controllers
- Tachometer/Pulse(Rate) meters
- Temperature/Humidity transducers
- Stepping motors/drivers/motion controllers
- Laser marking system(CO<sub>2</sub>, Nd:YAG)
- Laser welding/soldering system
- Photoelectric sensors
- Fiber optic sensors
- Pressure sensors
- Timers
- Display units
- Sensor controllers
- Graphic/Logic panels

**Autonics Corporation**  
http://www.autonics.com

Satisfiable Partner For Factory Automation

HEAD QUARTERS:  
41-5, Yongdang-dong, Yangsan-si, Gyeongnam, 626-847, Korea

OVERSEAS SALES:  
Bldg. 402 3rd Fl., Bucheon Techno Park, 193, Yakdeae-dong, Woomi-gu, Bucheon-si, Gyeonggi-do, 420-734, Korea  
TEL: 82-32-610-2730 / FAX: 82-32-329-0728  
E-mail: sales@autonics.com

The proposal of a product improvement and development: product@autonics.com

EP-KE-08-0281A