



Solid Electrolyte CO₂ Gas Sensor

(Model: MG811)

Manual

Version: 1.2

Valid from 2015-03-10

Zhengzhou Winsen Electronics Technology Co., Ltd

Statement

This manual copyright belongs to Zhengzhou Winsen Electronics Technology Co., LTD. Without the written permission, any part of this manual shall not be copied, translated, stored in database or retrieval system, also can't spread through electronic, copying, record ways.

Thanks for purchasing our product. In order to let customers use it better and reduce the faults caused by misuse, please read the manual carefully and operate it correctly in accordance with the instructions. If users disobey the terms or remove, disassemble, change the components inside of the sensor, we shall not be responsible for the loss.

The specific such as color, appearance, sizes &etc, please in kind prevail.

We are devoting ourselves to products development and technical innovation, so we reserve the right to improve the products without notice. Please confirm it is the valid version before using this manual. At the same time, users' comments on optimized using way are welcome.

Please keep the manual properly, in order to get help if you have questions during the usage in the future.

Zhengzhou Winsen Electronics Technology CO., LTD

MG811 Solid Electrolyte CO2 Gas Sensor

Profile

Chemical Sensor MG-811 adopts solid electrolyte battery principle to detect carbon dioxide. When the sensor is placed in the CO2 environment, the electrode reaction occurs between the battery positive and negative electrode, and electromotive force is generated between the sensor sensitive electrode and reference electrode. The output voltage signal can be used for carbon dioxide detection.

Features

Good sensitivity and selectivity to CO2
 Low humidity and temperature dependency
 Long stability and repeatability

Application

Air Quality Control
 Ferment Process Control
 Room Temperature CO2 concentration Detection



Technical Parameter

Model	MG811
Sensor Type	Solid Electrolyte
Target Gas	CO2
Detection Range	350 to 10000ppm(CO2)
Standard Encapsulation	Bakelite, metal cap
Heater Resistance	35Ω ± 3Ω
Heater Current	140±20mA
Heater Voltage	6.0V ± 0.1V AC or DC
Heater Consumption	850±120mW
Standard Working Conditions	-20~50°C, under 95%RH
Storage Conditions	-20~70°C, under 70%RH
Zero Point EMF	200-600mV
ΔE MF output signal	≧ 25mV/1000ppmCO ₂

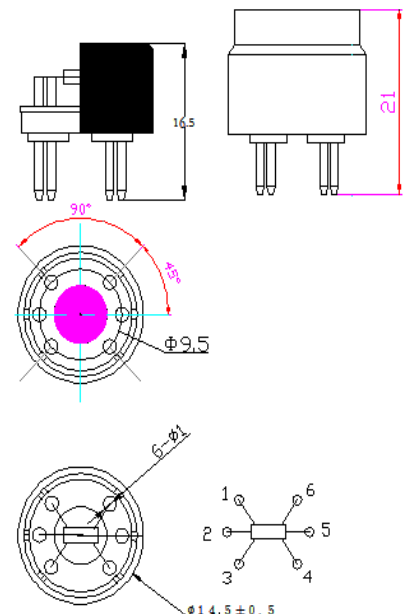

Basic Circuit

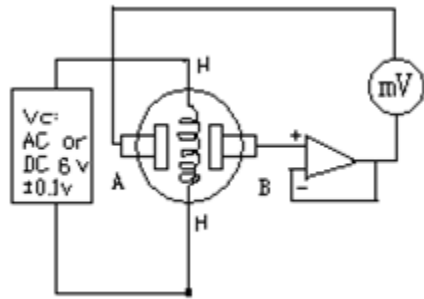

Sensor testing circuit pic. The resistance in this testing circuit should be greater than 100 GΩ, otherwise it would affect the sensor performance.

Description of Sensor Characters

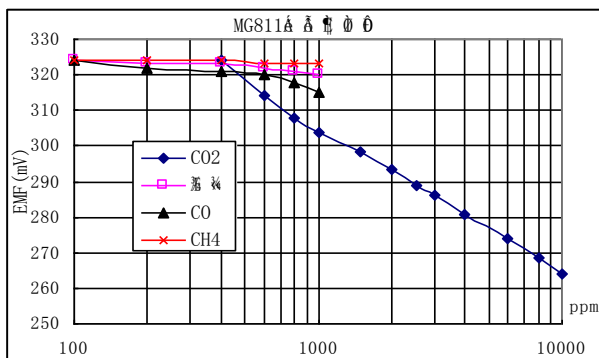

Fig3. Typical Sensitivity Curve

The ordinate is the sensor output voltage, the abscissa is concentration of gases. All tests are finished under standard test conditions. Different color curve shows different output voltage in different gases.

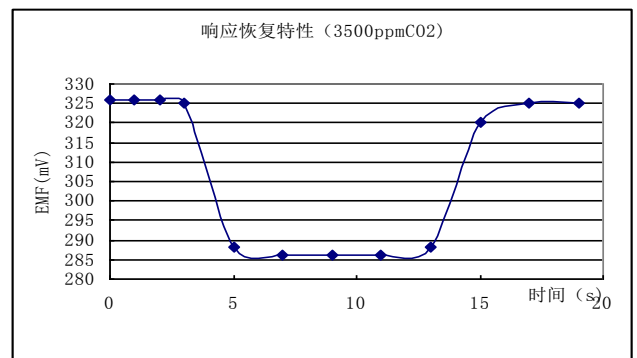

Fig4. Response and Resume

Fig5 shows the changing of V_{RL} in the process of putting the sensor into target gas and removing it out.

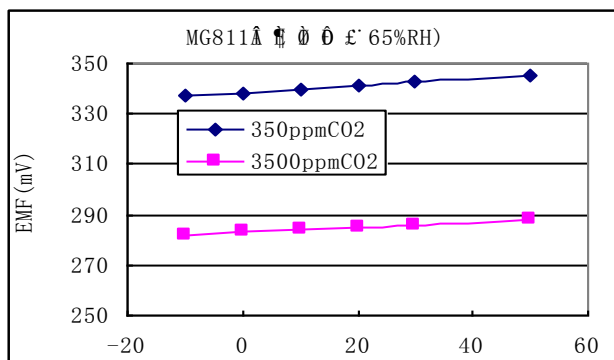

Fig5. Typical temperature characteristics

The ordinate is the sensor output voltage, the abscissa is concentration of gases.

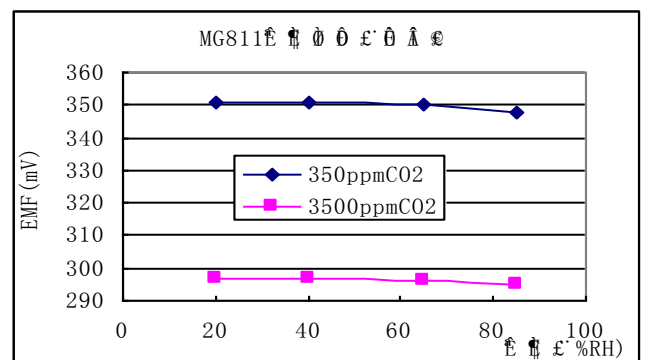

Fig6. Typical humidity characteristics

The ordinate is the sensor output voltage, the abscissa is concentration of gases.

Cautions

1 .Following conditions must be prohibited

1.1 Exposed to organic silicon steam

Sensing material will lose sensitivity and never recover if the sensor absorbs organic silicon steam. Sensors must be avoid exposing to silicon bond, fixture, silicon latex, putty or plastic contain silicon environment.

1.2 High Corrosive gas

If the sensors are exposed to high concentration corrosive gas (such as H₂S, SO_x, Cl₂, HCL etc.), it will not only result in corrosion of sensors structure, also it cause sincere sensitivity attenuation.

1.3 Alkali, Alkali metals salt, halogen pollution

The sensors performance will be changed badly if sensors be sprayed polluted by alkali metals salt especially brine, or be exposed to halogen such as fluorine.

1.4 Touch water

Sensitivity of the sensors will be reduced when splattered or dipped in water.

1.5 Freezing

Do avoid icing on sensor’s surface, otherwise sensing material will be broken and lost sensitivity.

1.6 Applied higher voltage

Applied voltage on sensor should not be higher than stipulated value, even if the sensor is not physically damaged or broken, it causes down-line or heater damaged, and bring on sensors’ sensitivity characteristic changed badly.

1.7 Voltage on wrong pins

For 6 pins sensor, Pin 2&5 is heating electrodes, Pin (1,3)/(4,6) are testing electrodes (Pin 1 connects with Pin 3, while Pin 4 connects with Pin 6).If apply voltage on Pin 1&3 or 4&6, it will make lead broken; and no signal putout if apply on pins 2&4.

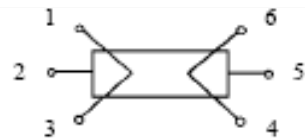

Fig8. Lead sketch

2 .Following conditions must be avoided

2.1 Water Condensation

Indoor conditions, slight water condensation will influence sensors’ performance lightly. However, if water condensation on sensors surface and keep a certain period, sensors’ sensitive will be decreased.

2.2 Used in high gas concentration

No matter the sensor is electrified or not, if it is placed in high gas concentration for long time, sensors characteristic will be affected. If lighter gas sprays the sensor, it will cause extremely damage.

2.3 Long time storage

The sensors resistance will drift reversibly if it’s stored for a long time without electrify, this drift is related with storage conditions. Sensors should be stored in airproof bag without volatile silicon compound. For the sensors with long time storage but no electrify, they need to be long galvanized aging time for stability before using. The suggested aging time as follow:

Stable2.

Storage Time	Suggested aging time
Less than one month	No less than 48 hours
1 ~ 6 months	No less than 72 hours
More than six months	No less than 168 hours

2.4 Long time exposed to adverse environment

No matter the sensors electrified or not, if exposed to adverse environment for long time, such as high humidity, high temperature, or high pollution etc., it will influence the sensors' performance badly.

2.5 Vibration

Continual vibration will result in sensors down-lead response then break. In transportation or assembling line, pneumatic screwdriver/ultrasonic welding machine can lead this vibration.

2.6 Concussion

If sensors meet strong concussion, it may lead its lead wire disconnected.

2.7 Usage Conditions

2.7.1 For sensor, handmade welding is optimal way. The welding conditions as follow:

- Soldering flux: Rosin soldering flux contains least chlorine
- homothermal soldering iron
- Temperature: 250°C
- Time: less than 3 seconds

2.7.1 If users choose wave-soldering, the following conditions should be obey:

- Soldering flux: Rosin soldering flux contains least chlorine
- Speed: 1-2 Meter/ Minute
- Warm-up temperature: 100±20°C
- Welding temperature: 250±10°C
- One time pass wave crest welding machine

If disobey the above using terms, sensors sensitivity will be reduced.

Note: To keep continual product development, we reserve right to change design features without prior notice !

Zhengzhou Winsen Electronics Technology Co., Ltd

Add: No.299, Jinsuo Road, National Hi-Tech Zone,
Zhengzhou 450001 China

Tel: +86-371-67169097/67169670

Fax: +86-371-60932988

E-mail: sales@winsensor.com

Website: www.winsen-sensor.com