

AVX
Surface Mount
Tantalum Capacitors

| | |
|---|-----------|
| Introduction | 2 |
| TAJ – Standard Series | 4 |
| TAJ – Low Profile Series | 8 |
| TPS – High Performance, Low ESR | 10 |
| TACmicrochip | 14 |
| TAZ – Specialist Series | 18 |
| CWR09 MIL-C-55365/4 | 22 |
| CWR11 MIL-C-55365/8 | 25 |
| Technical Summary & Application Guidelines | 28 |
| Packaging | 42 |
| Questions & Answers | 46 |
| Technical Publications | 48 |
| Fax Back Form | 49 |

Introduction



AVX Tantalum

AVX Paignton is the Divisional Headquarters for the Tantalum division which has manufacturing locations in Paignton in the UK, Biddeford in Maine, USA, Juarez in Mexico, Lanskrout in the Czech Republic and El Salvador.

The Division takes its name from the raw material used to make its main products, Tantalum Capacitors. Tantalum is

an element extracted from ores found alongside tin and niobium deposits; the major sources of supply are Canada, Brazil and Australasia.

So for high volume tantalum capacitors with leading edge technology call us first - **AVX your global partner.**

TECHNOLOGY TRENDS

The amount of capacitance possible in a tantalum capacitor is directly related to the type of tantalum powder used to manufacture the anode.

The graph following shows how the CV/g has steadily increased over time, thus allowing the production of larger and larger capacitances with the same physical volume. CV/g is the measure used to define the volumetric efficiency of a powder, a high CV/g means a higher capacitance from the same volume.

These improvements in the powder have been achieved through close development with the material suppliers.

AVX Tantalum is committed to driving the available technology forwards as is clearly identified by the new TACmicrochip technology and the standard codes under development.

If you have any specific requirements, please contact your local AVX sales office for details on how AVX Tantalum can assist you in addressing your future requirements.

Tantalum Powder CV/gm

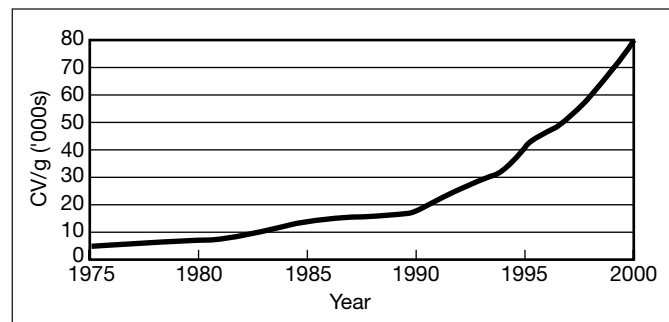

WORKING WITH THE CUSTOMER - ONE STOP SHOPPING

In line with our desire to become the number one supplier in the world for passive and interconnection components, AVX constantly feels the need to look forward and innovate.

It is not good enough to market the best products, the customer must have access to a service system which suits their needs and benefits their business.

The AVX 'one stop shopping' concept is already beneficial in meeting the needs of major OEMs while worldwide partnerships with only the premier division of distributors aids the smaller user.

Helping to market the breadth and depth of our electronic component line card and support our customers are a dedicated team of commercial sales people, applications engineers and product marketing managers. Their qualifica-

tions are hopefully always appropriate to your commercial need, but as higher levels of technical expertise are required, access directly to the appropriate department is seamless and transparent.

Total quality starts and finishes with our customer service, and where cost and quality are perceived as given quantities the AVX service invariably has us selected as the preferred supplier.

Facilities are equipped with instant worldwide computer and telecommunication links connected to every sales and production site worldwide. That ensures that our customers delivery requirements are consistently met wherever in the world they may be.



Introduction

AVX Tantalum



APPLICATIONS

| | | |
|---|--|---|
|  |  |  |
| 2-16 Volt Low ESR Low Profile Case 0603 available Low Failure Rate High Volumetric Efficiency Temperature Stability Stable over Time | 50 Volt @ 85°C 33 Volt @ 125°C Automotive range due second half 1998 High Reliability Temperature Stability QS9000 approved | 2-35 Volt Low ESR Low Profile Case 0603 available Low Failure Rate High Volumetric Efficiency Temperature Stability Stable over Time |

QUALITY STATEMENTS

AVX's focus is CUSTOMER satisfaction - customer satisfaction in the broadest sense: product quality, technical support, product availability and all at a competitive price.

In pursuance of the ethos and established goals of our corporate wide QV2000 program, it is the stated objective of AVX Tantalum to supply our customers with a world class service in the manufacturing and supplying of electronic components which will result in an adequate return on investment.

This world class service shall be defined as consistently supplying product and services of the highest quality and reliability.

This should encompass, but not be restricted to all aspects of the customer supply chain.

In addition any new or changed products, processes or services will be qualified to established standards of quality and reliability.

The objectives and guidelines listed above shall be achieved by the following codes of practice:

- 1. Continual objective evaluation of customer needs and expectations for the future and the leverage of all AVX resources to meet this challenge.*
- 2. By continually fostering and promoting culture of continuous improvement through ongoing training and empowered participation of employees at all levels of the company.*
- 3. By Continuous Process Improvement using sound engineering principles to enhance existing equipment, material and processes. This will involve the application of the science of S.P.C. focused on improving the Process Capability Index, Cpk.*

All AVX Tantalum manufacturing locations are ISO9000 approved and Paignton is approved to QS9000 - Automotive Quality System Requirements.



The TAJ standard series encompasses the five key sizes recognized by major OEMs throughout the world. The V case size has been added to the TAJ range to allow high CVs to be offered. The operational temperature is -55°C to

+85°C at rated voltage and up to +125°C with voltage derating in applications utilizing recommended series resistance.

TAJ is available in standard and extended ranges.

CASE DIMENSIONS: millimeters (inches)

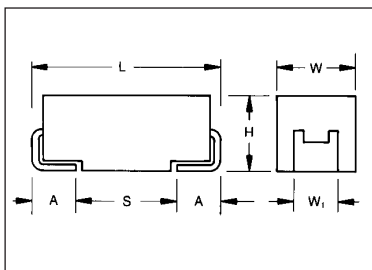

| Code | EIA Code | W+0.2 (0.008) -0.1 (0.004) | L±0.2 (0.008) | H+0.2 (0.008) -0.1 (0.004) | W ₁ ±0.2 (0.008) | A+0.3 (0.012) -0.2 (0.008) | S Min. |
|------|----------|-------------------------------|---------------|-------------------------------|-----------------------------|-------------------------------|-------------|
| A | 3216 | 1.6 (0.063) | 3.2 (0.126) | 1.6 (0.063) | 1.2 (0.047) | 0.8 (0.031) | 1.1 (0.043) |
| B | 3528 | 2.8 (0.110) | 3.5 (0.138) | 1.9 (0.075) | 2.2 (0.087) | 0.8 (0.031) | 1.4 (0.055) |
| C | 6032 | 3.2 (0.126) | 6.0 (0.236) | 2.6 (0.102) | 2.2 (0.087) | 1.3 (0.051) | 2.9 (0.114) |
| D | 7343 | 4.3 (0.169) | 7.3 (0.287) | 2.9 (0.114) | 2.4 (0.094) | 1.3 (0.051) | 4.4 (0.173) |
| E | 7343H | 4.3 (0.169) | 7.3 (0.287) | 4.1 (0.162) | 2.4 (0.094) | 1.3 (0.051) | 4.4 (0.173) |
| V | | 6.1 (0.240) | 7.3 (0.287) | 3.45±0.3 (0.136±0.012) | 3.1 (0.120) | 1.4 (0.055) | 3.4 (0.133) |

W₁ dimension applies to the termination width for A dimensional area only.

HOW TO ORDER

TAJ
Type

C
Case Code
See table above

106
Capacitance Code
pF code: 1st two digits represent significant figures
3rd digit represents multiplier (number of zeros to follow)

M
Tolerance
K=±10%
M=±20%

025
Rated DC Voltage

R
Packaging
Consult page 42 for details

Additional characters may be added for special requirements

TECHNICAL SPECIFICATIONS

Technical Data: All technical data relate to an ambient temperature of +25°C

Capacitance Range: 0.1µF to 470µF

Capacitance Tolerance: ±20%; ±10%

| Rated Voltage (V _R) | ≧ +85°C: | 2 | 4 | 6.3 | 10 | 16 | 20 | 25 | 35 | 50 |
|------------------------------------|-----------|-----|-----|-----|----|----|----|----|----|----|
| Category Voltage (V _C) | ≧ +125°C: | 1.3 | 2.7 | 4 | 7 | 10 | 13 | 17 | 23 | 33 |
| Surge Voltage (V _S) | ≧ +85°C: | 2.7 | 5.2 | 8 | 13 | 20 | 26 | 32 | 46 | 65 |
| Surge Voltage (V _S) | ≧ +125°C: | 1.7 | 3.2 | 5 | 8 | 12 | 16 | 20 | 28 | 40 |

Temperature Range: -55°C to +125°C

Environmental Classification: 55/125/56 (IEC 68-2)

Reliability: 1% per 1000h at 85°C with a 0.1Ω/V series impedance, 60% confidence level

Qualification: CECC 30801 - 005 issue 1

EIA 535BAAC

CAPACITANCE AND VOLTAGE RANGE (LETTER DENOTES CASE CODE)

| Capacitance | | Rated voltage (V _R) at 85°C | | | | | | | | |
|-------------|------|---|-----|-------|--------|-------|-------|-----|-------|-----|
| μF | Code | 2V | 4V | 6.3V | 10V | 16V | 20V | 25V | 35V | 50V |
| 0.10 | 104 | | | | | | | | A | A |
| 0.15 | 154 | | | | | | | | A | A/B |
| 0.22 | 224 | | | | | | | | A | A/B |
| 0.33 | 334 | | | | | | | | A | B |
| 0.47 | 474 | | | | | | | A | A/B | C |
| 0.68 | 684 | | | | | | A | A | A/B | C |
| 1.0 | 105 | | | | | A | A | A | B A | C |
| 1.5 | 155 | | | | A | A | A | A/B | B/C A | D C |
| 2.2 | 225 | | | A | A | A/B | A/B | B A | B/C | D |
| 3.3 | 335 | | | A | A | A/B | A/B | B/C | C B | D |
| 4.7 | 475 | | A | A | A/B | B A | B/C A | C B | C/D B | D |
| 6.8 | 685 | | A | A/B | A/B | B/C A | B/C | C B | D C | D |
| 10 | 106 | | A | A/B | B/C A | B/C A | C B | C/D | D C | E |
| 15 | 156 | | B A | B A | B/C A | C B | C/D B | D | D C | |
| 22 | 226 | | A | B/C A | C B A | C/D B | D C B | D C | E D | |
| 33 | 336 | | A/B | C B A | C/D B | D C B | D C | E D | D | |
| 47 | 476 | A | B A | C/D B | D C B | D C | D C | D | E | |
| 68 | 686 | | B/C | C/D B | D C | D C | E D | E | | |
| 100 | 107 | | B/C | D C B | D C | E D | V D/E | | | |
| 150 | 157 | B | B | C/D | E D | D/V | E | | | |
| 220 | 227 | | C/D | C/D | E D | V D/E | | | | |
| 330 | 337 | C | E | E | D/E/ V | E | | | | |
| 470 | 477 | | | E/V D | E | V | | | | |
| 680 | 687 | | D | E | V | | | | | |
| 1000 | 108 | D | E | | | | | | | |
| 1500 | 158 | E | | | | | | | | |

- = Standard Range
- = Extended Range
- = Development Range

RATINGS & PART NUMBER REFERENCE

| AVX Part No. | Case Size | Capacitance μF | DCL (μA) Max. | DF % Max. | ESR max. (Ω) @ 100 kHz |
|---|-----------|---------------------------|----------------------------|-----------|---------------------------------|
| 2 volt @ 85°C (1.2 volt @ 125°C) | | | | | |
| TAJA476*002 | A | 47 | 0.9 | 6 | 3.0 |
| 4 volt @ 85°C (2.5 volt @ 125°C) | | | | | |
| TAJA475*004 | A | 4.7 | 0.5 | 6 | 7.5 |
| TAJA685*004 | A | 6.8 | 0.5 | 6 | 6.5 |
| TAJA106*004 | A | 10 | 0.5 | 6 | 6.0 |
| TAJA156*004 | A | 15 | 0.6 | 6 | 4.0 |
| TAJB156*004 | B | 15 | 0.6 | 6 | 3.0 |
| TAJA226*004 | A | 22 | 0.9 | 6 | 3.5 |
| TAJA336*004 | A | 33 | 1.3 | 6 | 3.0 |
| TAJB336*004 | B | 33 | 1.4 | 6 | 2.8 |
| TAJB476*004 | B | 47 | 1.9 | 6 | 2.4 |
| TAJB686*004 | B | 68 | 2.7 | 6 | 1.8 |
| TAJC686*004 | C | 68 | 2.7 | 6 | 1.6 |
| TAJB107*004 | B | 100 | 4.0 | 8 | 1.6 |
| TAJC107*004 | C | 100 | 4.0 | 6 | 1.3 |
| TAJC227*004 | C | 220 | 8.8 | 8 | 1.2 |
| TAJD227*004 | D | 220 | 8.8 | 8 | 0.9 |
| TAJE337*004 | E | 330 | 13.2 | 8 | 0.9 |
| 6.3 volt @ 85°C (4 volt @ 125°C) | | | | | |
| TAJA225*006 | A | 2.2 | 0.5 | 6 | 9.0 |
| TAJA335*006 | A | 3.3 | 0.5 | 6 | 7.0 |
| TAJA475*006 | A | 4.7 | 0.5 | 6 | 6.0 |
| TAJA685*006 | A | 6.8 | 0.5 | 6 | 5.0 |
| TAJB685*006 | B | 6.8 | 0.5 | 6 | 4.0 |
| TAJA106*006 | A | 10 | 0.6 | 6 | 4.0 |
| TAJB106*006 | B | 10 | 0.6 | 6 | 3.0 |
| TAJA156*006 | A | 15 | 1.0 | 6 | 3.5 |
| TAJB156*006 | B | 15 | 1.0 | 6 | 2.5 |
| TAJA226*006 | A | 22 | 1.4 | 6 | 3.0 |
| TAJB226*006 | B | 22 | 1.4 | 6 | 2.5 |
| TAJC226*006 | C | 22 | 1.4 | 6 | 2.0 |
| TAJB336*006 | B | 33 | 2.1 | 6 | 2.2 |
| TAJC336*006 | C | 33 | 2.1 | 6 | 1.8 |
| TAJB476*006 | B | 47 | 3.0 | 6 | 2.0 |
| TAJC476*006 | C | 47 | 3.0 | 6 | 1.6 |
| TAJD476*006 | D | 47 | 3.0 | 6 | 1.1 |
| TAJB686*006 | B | 68 | 4.3 | 8 | 1.8 |
| TAJC686*006 | C | 68 | 4.3 | 6 | 1.6 |
| TAJD686*006 | D | 68 | 4.3 | 6 | 0.9 |
| TAJC107*006 | C | 100 | 6.3 | 6 | 1.4 |
| TAJD107*006 | D | 100 | 6.3 | 6 | 0.9 |
| TAJC157*006 | C | 150 | 9.5 | 6 | 1.3 |
| TAJD157*006 | D | 150 | 9.5 | 6 | 0.9 |
| TAJC227*006 | C | 220 | 13.9 | 10 | 1.2 |
| TAJD227*006 | D | 220 | 13.9 | 8 | 0.9 |
| TAJE337*006 | E | 330 | 20.8 | 8 | 0.9 |
| TAJE477*006 | E | 470 | 29.6 | 10 | 0.9 |
| TAJV477*006 | V | 470 | 29.6 | 8 | 0.9 |

All technical data relates to an ambient temperature of +25°C measured at 120 Hz, 0.5V RMS unless otherwise stated.

*Insert K for $\pm 10\%$ and M for $\pm 20\%$.

NOTE: We reserve the right to supply higher specification parts in the same case size, to the same reliability standards.

| AVX Part No. | Case Size | Capacitance μF | DCL (μA) Max. | DF % Max. | ESR max. (Ω) @ 100 kHz |
|--|-----------|---------------------------|----------------------------|-----------|---------------------------------|
| 10 volt @ 85°C (6.3 volt @ 125°C) | | | | | |
| TAJA155*010 | A | 1.5 | 0.5 | 6 | 10.0 |
| TAJA225*010 | A | 2.2 | 0.5 | 6 | 7.0 |
| TAJA335*010 | A | 3.3 | 0.5 | 6 | 5.5 |
| TAJA475*010 | A | 4.7 | 0.5 | 6 | 5.0 |
| TAJB475*010 | B | 4.7 | 0.5 | 6 | 4.0 |
| TAJA685*010 | A | 6.8 | 0.7 | 6 | 4.0 |
| TAJB685*010 | B | 6.8 | 0.7 | 6 | 3.0 |
| TAJA106*010 | A | 10 | 1.0 | 6 | 3.0 |
| TAJB106*010 | B | 10 | 1.0 | 6 | 2.5 |
| TAJC106*010 | C | 10 | 1.0 | 6 | 2.5 |
| TAJA156*010 | A | 15 | 1.5 | 6 | 3.2 |
| TAJB156*010 | B | 15 | 1.5 | 6 | 2.8 |
| TAJC156*010 | C | 15 | 1.5 | 6 | 2.0 |
| TAJB226*010 | B | 22 | 2.2 | 6 | 2.4 |
| TAJC226*010 | C | 22 | 2.2 | 6 | 1.8 |
| TAJB336*010 | B | 33 | 3.3 | 6 | 2.0 |
| TAJC336*010 | C | 33 | 3.3 | 6 | 1.6 |
| TAJD336*010 | D | 33 | 3.3 | 6 | 1.1 |
| TAJC476*010 | C | 47 | 4.7 | 6 | 1.2 |
| TAJD476*010 | D | 47 | 4.7 | 6 | 0.9 |
| TAJC686*010 | C | 68 | 6.8 | 6 | 1.3 |
| TAJD686*010 | D | 68 | 6.8 | 6 | 0.9 |
| TAJC107*010 | C | 100 | 10.0 | 6 | 1.2 |
| TAJD107*010 | D | 100 | 10.0 | 6 | 0.9 |
| TAJD157*010 | D | 150 | 15.0 | 8 | 0.9 |
| TAJE157*010 | E | 150 | 15.0 | 8 | 0.9 |
| TAJD227*010 | D | 220 | 22.0 | 8 | 0.9 |
| TAJE227*010 | E | 220 | 22.0 | 8 | 0.9 |
| TAJD337*010 | D | 330 | 33.0 | 8 | 0.9 |
| TAJE337*010 | E | 330 | 33.0 | 8 | 0.9 |
| TAJV337*010 | V | 330 | 33.0 | 8 | 0.9 |
| TAJE477*010 | E | 470 | 47.0 | 10 | 0.9 |
| 16 volt @ 85°C (10 volt @ 125°C) | | | | | |
| TAJA105*016 | A | 1.0 | 0.5 | 4 | 11.0 |
| TAJA155*016 | A | 1.5 | 0.5 | 6 | 8.0 |
| TAJA225*016 | A | 2.2 | 0.5 | 6 | 6.5 |
| TAJB225*016 | B | 2.2 | 0.5 | 6 | 5.5 |
| TAJA335*016 | A | 3.3 | 0.5 | 6 | 5.0 |
| TAJB335*016 | B | 3.3 | 0.5 | 6 | 4.5 |
| TAJA475*016 | A | 4.7 | 0.8 | 6 | 4.0 |
| TAJB475*016 | B | 4.7 | 0.8 | 6 | 3.5 |
| TAJA685*016 | A | 6.8 | 1.1 | 6 | 3.5 |
| TAJB685*016 | B | 6.8 | 1.1 | 6 | 2.5 |
| TAJC685*016 | C | 6.8 | 1.1 | 6 | 2.5 |
| TAJB106*016 | B | 10 | 1.6 | 6 | 2.8 |
| TAJC106*016 | C | 10 | 1.6 | 6 | 2.0 |
| TAJB156*016 | B | 15 | 2.4 | 6 | 2.5 |
| TAJC156*016 | C | 15 | 2.4 | 6 | 1.8 |
| TAJB226*016 | B | 22 | 3.5 | 6 | 2.3 |
| TAJC226*016 | C | 22 | 3.5 | 6 | 1.6 |
| TAJD226*016 | D | 22 | 3.5 | 6 | 1.1 |
| TAJC336*016 | C | 33 | 5.3 | 6 | 1.5 |
| TAJD336*016 | D | 33 | 5.3 | 6 | 0.9 |
| TAJC476*016 | C | 47 | 7.5 | 6 | 1.4 |
| TAJD476*016 | D | 47 | 7.5 | 6 | 0.9 |
| TAJD686*016 | D | 68 | 10.8 | 6 | 0.9 |
| TAJD107*016 | D | 100 | 16.0 | 6 | 0.9 |
| TAJE107*016 | E | 100 | 16.0 | 6 | 0.9 |
| TAJD157*016 | D | 150 | 24.0 | 6 | 0.9 |
| TAJV157*016 | V | 150 | 24.0 | 8 | 0.9 |
| TAJV227*016 | V | 220 | 35.2 | 8 | 0.9 |

For parametric information on development codes, please contact your local AVX sales office.

RATINGS & PART NUMBER REFERENCE

| AVX Part No. | Case Size | Capacitance μF | DCL (μA) Max. | DF % Max. | ESR max. (Ω) @ 100 kHz |
|---|-----------|---------------------------|----------------------------|-----------|---------------------------------|
| 20 volt @ 85°C (13 volt @ 125°C) | | | | | |
| TAJA684*020 | A | 0.68 | 0.5 | 4 | 12.0 |
| TAJA105*020 | A | 1.0 | 0.5 | 4 | 9.0 |
| TAJA155*020 | A | 1.5 | 0.5 | 6 | 6.5 |
| TAJA225*020 | A | 2.2 | 0.5 | 6 | 5.3 |
| TAJB225*020 | B | 2.2 | 0.5 | 6 | 3.5 |
| TAJA335*020 | A | 3.3 | 0.7 | 6 | 4.5 |
| TAJB335*020 | B | 3.3 | 0.7 | 6 | 3.0 |
| TAJA475*020 | A | 4.7 | 1.0 | 6 | 4.0 |
| TAJB475*020 | B | 4.7 | 1.0 | 6 | 3.0 |
| TAJC475*020 | C | 4.7 | 1.0 | 6 | 2.8 |
| TAJB685*020 | B | 6.8 | 1.4 | 6 | 2.5 |
| TAJC685*020 | C | 6.8 | 1.4 | 6 | 2.0 |
| TAJB106*020 | B | 10 | 2.0 | 6 | 2.1 |
| TAJC106*020 | C | 10 | 2.0 | 6 | 1.9 |
| TAJB156*020 | B | 15 | 3.0 | 6 | 2.0 |
| TAJC156*020 | C | 15 | 3.0 | 6 | 2.0 |
| TAJD156*020 | D | 15 | 3.0 | 6 | 1.1 |
| TAJC226*020 | C | 22 | 4.4 | 6 | 1.6 |
| TAJD226*020 | D | 22 | 4.4 | 6 | 0.9 |
| TAJC336*020 | C | 33 | 6.6 | 6 | 1.5 |
| TAJD336*020 | D | 33 | 6.6 | 6 | 0.9 |
| TAJD476*020 | D | 47 | 9.4 | 6 | 0.9 |
| TAJD686*020 | D | 68 | 13.6 | 6 | 0.9 |
| TAJE686*020 | E | 68 | 13.6 | 6 | 0.9 |
| TAJV107*020 | V | 100 | 20.0 | 8 | 0.9 |
| 25 volt @ 85°C (16 volt @ 125°C) | | | | | |
| TAJA474*025 | A | 0.47 | 0.5 | 4 | 14.0 |
| TAJA684*025 | A | 0.68 | 0.5 | 4 | 10.0 |
| TAJA105*025 | A | 1.0 | 0.5 | 4 | 8.0 |
| TAJA155*025 | A | 1.5 | 0.5 | 6 | 7.5 |
| TAJB155*025 | B | 1.5 | 0.5 | 6 | 5.0 |
| TAJA225*025 | A | 2.2 | 0.6 | 6 | 7.0 |
| TAJB225*025 | B | 2.2 | 0.6 | 6 | 4.5 |
| TAJB335*025 | B | 3.3 | 0.8 | 6 | 3.5 |
| TAJC335*025 | C | 3.3 | 0.8 | 6 | 2.8 |
| TAJB475*025 | B | 4.7 | 1.2 | 6 | 2.8 |
| TAJC475*025 | C | 4.7 | 1.2 | 6 | 2.4 |
| TAJB685*025 | B | 6.8 | 1.7 | 6 | 2.8 |
| TAJC685*025 | C | 6.8 | 1.7 | 6 | 2.0 |
| TAJC106*025 | C | 10 | 2.5 | 6 | 1.8 |
| TAJD106*025 | D | 10 | 2.5 | 6 | 1.2 |
| TAJD156*025 | D | 15 | 3.8 | 6 | 1.0 |
| TAJC226*025 | C | 22 | 5.5 | 6 | 1.4 |
| TAJD226*025 | D | 22 | 5.5 | 6 | 0.9 |
| TAJD336*025 | D | 33 | 8.3 | 6 | 0.9 |
| TAJE336*025 | E | 33 | 8.3 | 6 | 0.9 |
| TAJD476*025 | D | 47 | 11.8 | 6 | 0.9 |

| AVX Part No. | Case Size | Capacitance μF | DCL (μA) Max. | DF % Max. | ESR max. (Ω) @ 100 kHz |
|---|-----------|---------------------------|----------------------------|-----------|---------------------------------|
| 35 volt @ 85°C (23 volt @ 125°C) | | | | | |
| TAJA104*035 | A | 0.1 | 0.5 | 4 | 24.0 |
| TAJA154*035 | A | 0.15 | 0.5 | 4 | 21.0 |
| TAJA224*035 | A | 0.22 | 0.5 | 4 | 18.0 |
| TAJA334*035 | A | 0.33 | 0.5 | 4 | 15.0 |
| TAJA474*035 | A | 0.47 | 0.5 | 4 | 12.0 |
| TAJB474*035 | B | 0.47 | 0.5 | 4 | 10.0 |
| TAJA684*035 | A | 0.68 | 0.5 | 4 | 8.0 |
| TAJB684*035 | B | 0.68 | 0.5 | 4 | 8.0 |
| TAJA105*035 | A | 1.0 | 0.5 | 4 | 7.5 |
| TAJB105*035 | B | 1.0 | 0.5 | 4 | 6.5 |
| TAJA155*035 | A | 1.5 | 0.5 | 6 | 7.5 |
| TAJB155*035 | B | 1.5 | 0.5 | 6 | 5.2 |
| TAJC155*035 | C | 1.5 | 0.5 | 6 | 4.5 |
| TAJB225*035 | B | 2.2 | 0.8 | 6 | 4.2 |
| TAJC225*035 | C | 2.2 | 0.8 | 6 | 3.5 |
| TAJB335*035 | B | 3.3 | 1.2 | 6 | 3.5 |
| TAJC335*035 | C | 3.3 | 1.2 | 6 | 2.5 |
| TAJB475*035 | B | 4.7 | 1.6 | 6 | 3.1 |
| TAJC475*035 | C | 4.7 | 1.6 | 6 | 2.2 |
| TAJD475*035 | D | 4.7 | 1.6 | 6 | 1.5 |
| TAJC685*035 | C | 6.8 | 2.4 | 6 | 1.8 |
| TAJD685*035 | D | 6.8 | 2.4 | 6 | 1.3 |
| TAJC106*035 | C | 10.0 | 3.5 | 6 | 1.6 |
| TAJD106*035 | D | 10.0 | 3.5 | 6 | 1.0 |
| TAJC156*035 | C | 15.0 | 5.3 | 6 | 1.4 |
| TAJD156*035 | D | 15.0 | 5.3 | 6 | 0.9 |
| TAJD226*035 | D | 22.0 | 7.7 | 6 | 0.9 |
| TAJE226*035 | E | 22.0 | 7.7 | 6 | 0.9 |
| TAJD336*035 | D | 33.0 | 11.6 | 6 | 0.9 |
| 50 volt @ 85°C (33 volt @ 125°C) | | | | | |
| TAJA104*050 | A | 0.1 | 0.5 | 4 | 22.0 |
| TAJA154*050 | A | 0.15 | 0.5 | 4 | 15.0 |
| TAJB154*050 | B | 0.15 | 0.5 | 4 | 17.0 |
| TAJA224*050 | A | 0.22 | 0.5 | 4 | 18.0 |
| TAJB224*050 | B | 0.22 | 0.5 | 4 | 14.0 |
| TAJB334*050 | B | 0.33 | 0.5 | 4 | 12.0 |
| TAJC474*050 | C | 0.47 | 0.5 | 4 | 8.0 |
| TAJC684*050 | C | 0.68 | 0.5 | 4 | 7.0 |
| TAJC105*050 | C | 1.0 | 0.5 | 4 | 5.5 |
| TAJC155*050 | C | 1.5 | 0.8 | 6 | 4.5 |
| TAJD155*050 | D | 1.5 | 0.8 | 6 | 4.0 |
| TAJD225*050 | D | 2.2 | 1.1 | 6 | 2.5 |
| TAJD335*050 | D | 3.3 | 1.7 | 6 | 2.0 |
| TAJD475*050 | D | 4.7 | 2.4 | 6 | 1.4 |
| TAJD685*050 | D | 6.8 | 3.4 | 6 | 1.0 |
| TAJE106*050 | E | 10.0 | 5.0 | 8 | 0.9 |

For parametric information on development codes, please contact your local AVX sales office.

All technical data relates to an ambient temperature of +25°C measured at 120 Hz, 0.5V RMS unless otherwise stated.

*Insert K for $\pm 10\%$ and M for $\pm 20\%$.

NOTE: We reserve the right to supply higher specification parts in the same case size, to the same reliability standards.

TAJ Series



Low Profile



Three additional case sizes are available in the TAJ range offering low profile solid tantalum chip capacitors. Designed for applications where maximum height of components above or below board are of

prime consideration, this height of 1.2mm equates to that of a standard integrated circuit package after mounting. The S&T footprints are identical to the A&B case size parts.

CASE DIMENSIONS: millimeters (inches)

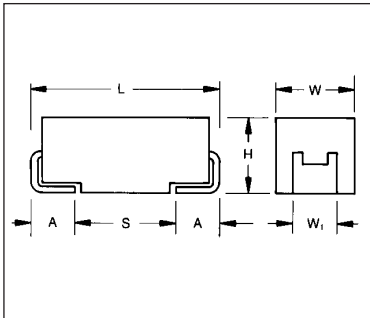

| Code | EIA Code | W+0.2 (0.008) -0.1 (0.004) | L±0.2 (0.008) | H Max. | W ₁ ±0.1 (0.004) | A+0.3 (0.012) -0.1 (0.004) | S Min. |
|------|----------|-------------------------------|---------------|-------------|-----------------------------|-------------------------------|--------------|
| R* | 2012 | 1.3 (0.051) | 2.05 (0.081) | 1.2 (0.047) | 1.2 (0.047) | 0.5 (0.020) | 0.85 (0.033) |
| S** | 3216L | 1.6 (0.063) | 3.2 (0.126) | 1.2 (0.047) | 1.2 (0.047) | 0.8 (0.031) | 1.1 (0.043) |
| T** | 3528L | 2.8 (0.110) | 3.5 (0.138) | 1.2 (0.047) | 2.2 (0.087) | 0.8 (0.031) | 1.4 (0.055) |
| W | — | 3.2 (0.126) | 6.0 (0.236) | 1.5 (0.059) | 2.2 (0.087) | 1.3 (0.051) | 2.9 (0.114) |
| Y | — | 4.3 (0.169) | 7.3 (0.287) | 2.0 (0.079) | 2.4 (0.094) | 1.3 (0.051) | 4.4 (0.173) |

* 0805 Equivalent

** Low Profile Versions of A & B Case

W₁ dimension applies to the termination width for A dimensional area only.
Pad Stand-off is 0.1±0.1.

CAPACITANCE AND VOLTAGE RANGE (LETTER DENOTES CASE CODE)

| Capacitance | | Rated voltage (V _R) at 85°C | | | | | | |
|-------------|------|---|-----|------|-----|-------|-------|-----|
| µF | Code | 2V | 4V | 6.3V | 10V | 16V | 20V | 25V |
| 0.10 | 104 | | | | | | R/S | |
| 0.15 | 154 | | | | | | R/S | |
| 0.22 | 224 | | | | | | R/S | |
| 0.33 | 334 | | | | | | R/S | |
| 0.47 | 474 | | | | | | R/S | |
| 0.68 | 684 | | | | | R/S | R/S/T | |
| 1.0 | 105 | | | | R/S | R/S/T | R/S/T | |
| 1.5 | 155 | | | R/S | R/S | S | T | |
| 2.2 | 225 | | R/S | R/S | R/S | T | T | |
| 3.3 | 335 | | R/S | R/S | S/T | T | | |
| 4.7 | 475 | R | R/S | S/T | T R | | | |
| 6.8 | 685 | R | S/T | T | T | | | W |
| 10 | 106 | S | R/T | R | T | W | | |
| 15 | 156 | | | T | | | | X |
| 22 | 226 | | | | | | W | Y |
| 33 | 336 | | | W | | W | | |
| 47 | 476 | | | | | X | X | |
| 68 | 686 | | | | Y W | Y | Y | |
| 100 | 107 | | | W | Y | | | |
| 150 | 157 | | W | | X | | | |
| 220 | 227 | W | | X | Y | | | |
| 330 | 337 | W | | Y | | | | |
| 470 | 477 | X | X | | | | | |
| 680 | 687 | X/Y | Y | | | | | |
| 1000 | 108 | Y | | | | | | |

■ = Standard Range

■ = Development Range

X = 1.5mm height in a D case footprint

RATINGS & PART NUMBER REFERENCE

| AVX Part No. | Case Size | Capacitance μF | DCL (μA) Max. | DF % Max. | ESR max. (Ω) @ 100 kHz |
|-----------------|-----------|---------------------------|----------------------------|-----------|---------------------------------|
| 2 volt | | | | | |
| TAJR475*002 | R | 4.7 | 0.5 | 6 | 20.0 |
| TAJR685*002 | R | 6.8 | 0.5 | 6 | 20.0 |
| TAJS106*002 | S | 10.0 | 0.5 | 6 | 20.0 |
| 4 volt | | | | | |
| TAJR225*004 | R | 2.2 | 0.5 | 6 | 25.0 |
| TAJS225*004 | S | 2.2 | 0.5 | 6 | 25.0 |
| TAJR335*004 | R | 3.3 | 0.5 | 6 | 20.0 |
| TAJS335*004 | S | 3.3 | 0.5 | 6 | 18.0 |
| TAJR475*004 | R | 4.7 | 0.5 | 6 | 12.0 |
| TAJS475*004 | S | 4.7 | 0.5 | 6 | 10.0 |
| TAJS685*004 | S | 6.8 | 0.5 | 6 | 8.0 |
| TAJT685*004 | T | 6.8 | 0.5 | 6 | 6.0 |
| TAJR106*004 | R | 10.0 | 0.5 | 6 | 10.0 |
| TAJT106*004 | T | 10.0 | 0.5 | 6 | 5.0 |
| 6.3 volt | | | | | |
| TAJR155*006 | R | 1.5 | 0.5 | 6 | 25.0 |
| TAJS155*006 | S | 1.5 | 0.5 | 6 | 25.0 |
| TAJR225*006 | R | 2.2 | 0.5 | 6 | 20.0 |
| TAJS225*006 | S | 2.2 | 0.5 | 6 | 18.0 |
| TAJR335*006 | R | 3.3 | 0.5 | 6 | 12.0 |
| TAJS335*006 | S | 3.3 | 0.5 | 6 | 9.0 |
| TAJS475*006 | S | 4.7 | 0.5 | 6 | 7.5 |
| TAJT475*006 | T | 4.7 | 0.5 | 6 | 6.0 |
| TAJT685*006 | T | 6.8 | 0.5 | 6 | 5.0 |
| TAJT156*006 | T | 15.0 | 1.0 | 6 | 4.5 |
| TAJW336*006 | W | 33.0 | 2.1 | 6 | 2.0 |
| 10 volt | | | | | |
| TAJR105*010 | R | 1.0 | 0.5 | 4 | 25.0 |
| TAJS105*010 | S | 1.0 | 0.5 | 4 | 25.0 |
| TAJR155*010 | R | 1.5 | 0.5 | 6 | 20.0 |
| TAJS155*010 | S | 1.5 | 0.5 | 6 | 20.0 |
| TAJR225*010 | R | 2.2 | 0.5 | 6 | 15.0 |
| TAJS225*010 | S | 2.2 | 0.5 | 6 | 12.0 |
| TAJS335*010 | S | 3.3 | 0.5 | 6 | 8.0 |
| TAJT335*010 | T | 3.3 | 0.5 | 6 | 6.0 |
| TAJT475*010 | T | 4.7 | 0.5 | 6 | 5.0 |
| TAJT685*010 | T | 6.8 | 1.0 | 6 | 4.0 |
| TAJT106*010 | T | 10.0 | 1.0 | 6 | 3.0 |
| TAJY686*010 | Y | 68 | 6.8 | 6 | 0.9 |
| TAJY107*010 | Y | 100 | 10 | 6 | 0.9 |

| AVX Part No. | Case Size | Capacitance μF | DCL (μA) Max. | DF % Max. | ESR max. (Ω) @ 100 kHz |
|----------------|-----------|---------------------------|----------------------------|-----------|---------------------------------|
| 16 volt | | | | | |
| TAJR684*016 | R | 0.68 | 0.5 | 4 | 25.0 |
| TAJS684*016 | S | 0.68 | 0.5 | 4 | 25.0 |
| TAJR105*016 | R | 1.0 | 0.5 | 4 | 20.0 |
| TAJS105*016 | S | 1.0 | 0.5 | 4 | 15.0 |
| TAJT105*016 | T | 1.0 | 0.5 | 4 | 15.0 |
| TAJS155*016 | S | 1.5 | 0.5 | 6 | 12.0 |
| TAJT225*016 | T | 2.2 | 0.5 | 6 | 6.5 |
| TAJT335*016 | T | 3.3 | 0.5 | 6 | 5.0 |
| TAJW106*016 | W | 10.0 | 1.6 | 6 | 2.0 |
| 20 volt | | | | | |
| TAJR104*020 | R | 0.1 | 0.5 | 4 | 25.0 |
| TAJS104*020 | S | 0.1 | 0.5 | 4 | 25.0 |
| TAJR154*020 | R | 0.15 | 0.5 | 4 | 25.0 |
| TAJS154*020 | S | 0.15 | 0.5 | 4 | 25.0 |
| TAJR224*020 | R | 0.22 | 0.5 | 4 | 25.0 |
| TAJS224*020 | S | 0.22 | 0.5 | 4 | 25.0 |
| TAJR334*020 | R | 0.33 | 0.5 | 4 | 25.0 |
| TAJS334*020 | S | 0.33 | 0.5 | 4 | 25.0 |
| TAJR474*020 | R | 0.47 | 0.5 | 4 | 25.0 |
| TAJS474*020 | S | 0.47 | 0.5 | 4 | 25.0 |
| TAJR684*020 | R | 0.68 | 0.5 | 4 | 25.0 |
| TAJS684*020 | S | 0.68 | 0.5 | 4 | 25.0 |
| TAJT684*020 | T | 0.68 | 0.5 | 4 | 15.0 |
| TAJR105*020 | R | 1.0 | 0.5 | 4 | 20.0 |
| TAJS105*020 | S | 1.0 | 0.5 | 4 | 12.0 |
| TAJT105*020 | T | 1.0 | 0.5 | 4 | 9.0 |
| TAJT155*020 | T | 1.5 | 0.5 | 6 | 6.5 |
| TAJT225*020 | T | 2.2 | 0.5 | 6 | 6.0 |

For parametric information on development codes, please contact your local AVX sales office.

All technical data relates to an ambient temperature of +25°C measured at 120 Hz, 0.5V RMS unless otherwise stated.

*Insert K for $\pm 10\%$ and M for $\pm 20\%$.

NOTE: We reserve the right to supply higher specification parts in the same case size, to the same reliability standards.

TPS Series



Low ESR



The TPS surface mount products have inherently low ESR (equivalent series resistance) and are capable of higher ripple current handling, producing lower ripple voltages, less power and heat dissipation than standard product for the most efficient use of circuit power. TPS has been designed, manufactured, and

preconditioned for optimum performance in typical power supply applications. By combining the latest improvements in tantalum powder technology, improved manufacturing processes, and application specific preconditioning tests, AVX is able to provide a technologically superior alternative to the standard range.

CASE DIMENSIONS: millimeters (inches)

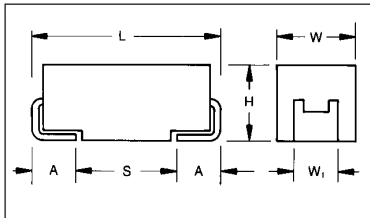

| Code | EIA Code | W+0.2 (0.008) -0.1 (0.004) | L±0.2 (0.008) | H+0.2 (0.008) -0.1 (0.004) | W ₁ ±0.2 (0.008) | A+0.3 (0.012) -0.2 (0.008) | S Min. |
|------|----------|-------------------------------|---------------|-------------------------------|-----------------------------|-------------------------------|-------------|
| A | 3216 | 1.6 (0.063) | 3.2 (0.126) | 1.6 (0.063) | 1.2 (0.047) | 0.8 (0.031) | 1.1 (0.043) |
| B | 3528 | 2.8 (0.110) | 3.5 (0.138) | 1.9 (0.075) | 2.2 (0.087) | 0.8 (0.031) | 1.4 (0.055) |
| C | 6032 | 3.2 (0.126) | 6.0 (0.236) | 2.6 (0.102) | 2.2 (0.087) | 1.3 (0.051) | 2.9 (0.114) |
| D | 7343 | 4.3 (0.169) | 7.3 (0.287) | 2.9 (0.114) | 2.4 (0.094) | 1.3 (0.051) | 4.4 (0.173) |
| E | 7343H | 4.3 (0.169) | 7.3 (0.287) | 4.1 (0.162) | 2.4 (0.094) | 1.3 (0.051) | 4.4 (0.173) |
| V | | 6.1 (0.240) | 7.3 (0.287) | 3.45 ±0.3 (0.136±0.012) | 3.1 (0.120) | 1.4 (0.055) | 3.4 (0.133) |

W₁ dimension applies to the termination width for A dimensional area only.

HOW TO ORDER

TPS

Type

D

Case Size
See table above

107

Capacitor Code
pF code: 1st two digits represent significant figures, 3rd digit represents multiplier (number of zeros to follow)

M

Tolerance
K=±10%
M=±20%

010

Rated DC Voltage

R

Packaging
Consult page 42 for details

0100

Maximum ESR in Milliohms
*See note below

NOTE: The EIA & CECC standards for low ESR Solid Tantalum Capacitors allow an ESR movement to 1.25 times catalog limit post mounting

TECHNICAL SPECIFICATIONS

| | | | | | | | | |
|------------------------------------|---|-----|----|----|----|----|----|--|
| Technical Data: | All technical data relate to an ambient temperature of +25°C | | | | | | | |
| Capacitance Range: | 1.5µF to 470µF | | | | | | | |
| Capacitance Tolerance: | ±20%; ±10% | | | | | | | |
| Rated Voltage (V _R) | ≧ +85°C: | 6.3 | 10 | 16 | 20 | 25 | 35 | |
| Category Voltage (V _C) | ≧ +125°C: | 4 | 7 | 10 | 13 | 17 | 23 | |
| Surge Voltage (V _S) | ≧ +85°C: | 8 | 13 | 20 | 26 | 32 | 46 | |
| Surge Voltage (V _S) | ≧ +125°C: | 5 | 8 | 12 | 16 | 20 | 28 | |
| Temperature Range: | -55°C to +125°C | | | | | | | |
| Environmental Classification: | 55/125/56 (IEC 68-2) | | | | | | | |
| Reliability: | 1% per 1000h at 85°C with 0.1Ω/V series impedance, 60% confidence level | | | | | | | |



CAPACITANCE AND VOLTAGE RANGE (LETTER DENOTES CASE CODE)

| Capacitance | | Rated voltage (V_R) at 85°C | | | | | |
|---------------|------|---------------------------------|----------------------------------|--------------------------|------------|------------|----------------------|
| μF | Code | 6.3V | 10V | 16V | 20V | 25V | 35V |
| 1.5 | 155 | | | | | A(3000) | |
| 3.3 | 335 | | | A(3500) | | | |
| 4.7 | 475 | | | | A(1800) | B(1500) | C(600) |
| 6.8 | 685 | | | | | | |
| 10 | 106 | | A(1800) | | B(1000) | C(500) | D(300) E(200) |
| 15 | 156 | A(1500) | A(1000) | B(800) | C(450) | | C(450) D(300) |
| 22 | 226 | | B(700) | C(375) | | D(200) | D(400) E(200-300) |
| 33 | 336 | B(600) | C(375-500) | C(300) | D(200) | E(175-300) | D(300) |
| 47 | 476 | | C(350) | C(350) D(150-200) | E(150) | D(250) | |
| 68 | 686 | | | D(150) | E(125-150) | V(95-300) | |
| 100 | 107 | C(150) | C(200) D(65-140) E(125) | D(125-150) E(100-150) | V(85-200) | | |
| 150 | 157 | D(125) | D(100) | D(150) V(75) | | | |
| 220 | 227 | D(100) | D(150) E(60-150) V(60) | V(75-150) | | | |
| 330 | 337 | E(100-150) V(60-100) | D(150) E(60-100) V(60-100) | | | | |
| 470 | 477 | E(50-200) V(55-100) | E(50-200) | | | | |

ESR limits quoted in brackets are in milliohms

RATINGS & PART NUMBER REFERENCE

| AVX Part No. | Case Size | Capacitance μF | Rated Voltage | DCL (μA) Max. | DF % Max. | ESR Max. ($\text{m}\Omega$) @100kHz | 100kHz Ripple Current (mA) Ratings | | |
|------------------|-----------|---------------------------|---------------|----------------------------|-----------|---------------------------------------|------------------------------------|------|-------|
| | | | | | | | 25°C | 85°C | 125°C |
| TPSA156*006R1500 | A | 15 | 6.3 | 0.9 | 6 | 1500 | 224 | 200 | 89 |
| TPSB336*006R0600 | B | 33 | 6.3 | 2.1 | 6 | 600 | 376 | 337 | 151 |
| TPSC107*006R0150 | C | 100 | 6.3 | 6.3 | 6 | 150 | 856 | 766 | 343 |
| TPSD157*006R0125 | D | 150 | 6.3 | 9.5 | 6 | 125 | 1095 | 980 | 438 |
| TPSD227*006R0100 | D | 220 | 6.3 | 13.9 | 6 | 100 | 1225 | 1095 | 490 |
| TPSE337*006R0100 | E | 330 | 6.3 | 20.8 | 8 | 100 | 1285 | 1149 | 514 |
| TPSE337*006R0125 | E | 330 | 6.3 | 20.8 | 8 | 125 | 1149 | 1028 | 460 |
| TPSE337*006R0150 | E | 330 | 6.3 | 20.8 | 8 | 150 | 1049 | 938 | 420 |
| TPSV337*006R0060 | V | 330 | 6.3 | 20.8 | 8 | 60 | 2041 | 1826 | 816 |
| TPSV337*006R0100 | V | 330 | 6.3 | 20.8 | 8 | 100 | 1581 | 1414 | 632 |
| TPSE477*006R0050 | E | 470 | 6.3 | 29.6 | 10 | 50 | 1817 | 1625 | 727 |
| TPSE477*006R0100 | E | 470 | 6.3 | 29.6 | 10 | 100 | 1285 | 1149 | 514 |
| TPSE477*006R0200 | E | 470 | 6.3 | 29.6 | 10 | 200 | 908 | 812 | 363 |
| TPSV477*006R0055 | V | 470 | 6.3 | 29.6 | 10 | 55 | 2132 | 1907 | 853 |
| TPSV477*006R0100 | V | 470 | 6.3 | 29.6 | 10 | 100 | 1581 | 1414 | 632 |
| TPSA106*010R1800 | A | 10 | 10 | 1.0 | 6 | 1800 | 204 | 183 | 82 |
| TPSA156*010R1000 | A | 15 | 10 | 1.5 | 6 | 1000 | 274 | 245 | 110 |
| TPSB226*010R0700 | B | 22 | 10 | 2.2 | 6 | 700 | 348 | 312 | 139 |
| TPSC336*010R0375 | C | 33 | 10 | 3.3 | 6 | 375 | 542 | 484 | 217 |
| TPSC336*010R0500 | C | 33 | 10 | 3.3 | 6 | 500 | 469 | 420 | 188 |
| TPSC476*010R0350 | C | 47 | 10 | 4.7 | 6 | 350 | 561 | 501 | 224 |
| TPSC107*010R0200 | C | 100 | 10 | 10.0 | 8 | 200 | 742 | 663 | 297 |
| TPSD107*010R0065 | D | 100 | 10 | 10.0 | 6 | 65 | 1519 | 1359 | 608 |
| TPSD107*010R0080 | D | 100 | 10 | 10.0 | 6 | 80 | 1369 | 1225 | 547 |
| TPSD107*010R0100 | D | 100 | 10 | 10.0 | 6 | 100 | 1225 | 1095 | 490 |
| TPSD107*010R0125 | D | 100 | 10 | 10.0 | 6 | 125 | 1095 | 980 | 438 |
| TPSD107*010R0140 | D | 100 | 10 | 10.0 | 6 | 140 | 1035 | 926 | 414 |
| TPSD107*010R0150 | D | 100 | 10 | 10.0 | 6 | 150 | 1000 | 894 | 400 |
| TPSE107*010R0125 | E | 100 | 10 | 10.0 | 6 | 125 | 1149 | 1028 | 460 |
| TPSD157*010R0100 | D | 150 | 10 | 15.0 | 6 | 100 | 1225 | 1095 | 490 |
| TPSD227*010R0150 | D | 220 | 10 | 22.0 | 8 | 150 | 1000 | 894 | 400 |
| TPSE227*010R0060 | E | 220 | 10 | 22.0 | 8 | 60 | 1658 | 1483 | 663 |
| TPSE227*010R0100 | E | 220 | 10 | 22.0 | 8 | 100 | 1285 | 1149 | 514 |
| TPSE227*010R0125 | E | 220 | 10 | 22.0 | 8 | 125 | 1149 | 1028 | 460 |
| TPSE227*010R0150 | E | 220 | 10 | 22.0 | 8 | 150 | 1049 | 938 | 420 |
| TPSV227*010R0060 | V | 220 | 10 | 22.0 | 8 | 60 | 2041 | 1826 | 817 |
| TPSD337*010R0150 | D | 330 | 10 | 33.0 | 8 | 150 | 1000 | 894 | 400 |
| TPSE337*010R0060 | E | 330 | 10 | 33.0 | 8 | 60 | 1658 | 1483 | 663 |
| TPSE337*010R0100 | E | 330 | 10 | 33.0 | 8 | 100 | 1285 | 1149 | 514 |
| TPSV337*010R0060 | V | 330 | 10 | 33.0 | 8 | 60 | 2041 | 1826 | 817 |
| TPSV337*010R0100 | V | 330 | 10 | 33.0 | 10 | 100 | 1581 | 1414 | 632 |
| TPSE477*010R0050 | E | 470 | 10 | 47.0 | 10 | 50 | 1817 | 1625 | 727 |
| TPSE477*010R0100 | E | 470 | 10 | 47.0 | 10 | 100 | 1285 | 1149 | 514 |
| TPSE477*010R0200 | E | 470 | 10 | 47.0 | 10 | 200 | 908 | 812 | 363 |

RATINGS & PART NUMBER REFERENCE

| AVX Part No. | Case Size | Capacitance μF | Rated Voltage | DCL (μA) Max. | DF % Max. | ESR Max. ($\text{m}\Omega$) @100kHz | 100kHz Ripple Current (mA) Ratings | | |
|------------------|-----------|---------------------------|---------------|----------------------------|-----------|---------------------------------------|------------------------------------|------|-------|
| | | | | | | | 25°C | 85°C | 125°C |
| TPSA335*016R3500 | A | 3.3 | 16 | 0.5 | 6 | 3500 | 146 | 131 | 59 |
| TPSB156*016R0800 | B | 15 | 16 | 2.4 | 6 | 800 | 326 | 292 | 130 |
| TPSC226*016R0375 | C | 22 | 16 | 3.5 | 6 | 375 | 542 | 484 | 217 |
| TPSC336*016R0300 | C | 33 | 16 | 5.3 | 6 | 300 | 606 | 542 | 242 |
| TPSC476*016R0350 | C | 47 | 16 | 7.5 | 6 | 350 | 561 | 501 | 224 |
| TPSD476*016R0150 | D | 47 | 16 | 7.5 | 6 | 150 | 1000 | 894 | 400 |
| TPSD476*016R0200 | D | 47 | 16 | 7.5 | 6 | 200 | 866 | 775 | 346 |
| TPSD686*016R0150 | D | 68 | 16 | 10.9 | 6 | 150 | 1000 | 894 | 400 |
| TPSD107*016R0125 | D | 100 | 16 | 16.0 | 6 | 125 | 1095 | 980 | 438 |
| TPSD107*016R0150 | D | 100 | 16 | 16.0 | 6 | 150 | 1000 | 894 | 400 |
| TPSE107*016R0100 | E | 100 | 16 | 16.0 | 6 | 100 | 1285 | 1149 | 514 |
| TPSE107*016R0125 | E | 100 | 16 | 16.0 | 6 | 125 | 1149 | 1028 | 460 |
| TPSE107*016R0150 | E | 100 | 16 | 16.0 | 6 | 150 | 1049 | 938 | 420 |
| TPSD157*016R0150 | D | 150 | 16 | 24.0 | 8 | 150 | 1000 | 894 | 400 |
| TPSV157*016R0075 | V | 150 | 16 | 24.0 | 8 | 75 | 1826 | 1633 | 730 |
| TPSE227*016R0100 | E | 220 | 16 | 35.2 | 8 | 100 | 1285 | 1149 | 514 |
| TPSV227*016R0075 | V | 220 | 16 | 35.2 | 8 | 75 | 1826 | 1633 | 730 |
| TPSV227*016R0150 | V | 220 | 16 | 35.2 | 10 | 150 | 1291 | 1155 | 516 |
| TPSA475*020R1800 | A | 4.7 | 20 | 0.9 | 6 | 1800 | 204 | 183 | 82 |
| TPSB106*020R1000 | B | 10 | 20 | 2.0 | 6 | 1000 | 292 | 261 | 117 |
| TPSC156*020R0450 | C | 15 | 20 | 3.0 | 6 | 450 | 494 | 442 | 198 |
| TPSD336*020R0200 | D | 33 | 20 | 6.6 | 6 | 200 | 866 | 775 | 346 |
| TPSE476*020R0150 | E | 47 | 20 | 9.4 | 6 | 150 | 1049 | 938 | 420 |
| TPSE686*020R0125 | E | 68 | 20 | 13.6 | 6 | 125 | 1149 | 1028 | 160 |
| TPSE686*020R0150 | E | 68 | 20 | 13.6 | 6 | 150 | 1049 | 938 | 420 |
| TPSV107*020R0085 | V | 100 | 20 | 20.0 | 8 | 85 | 1715 | 1534 | 686 |
| TPSV107*020R0200 | V | 100 | 20 | 20.0 | 10 | 200 | 1118 | 1000 | 447 |
| TPSA155*025R3000 | A | 1.5 | 25 | 0.5 | 6 | 3000 | 158 | 141 | 63 |
| TPSB475*025R1500 | B | 4.7 | 25 | 1.2 | 6 | 1500 | 238 | 213 | 95 |
| TPSC106*025R0500 | C | 10 | 25 | 2.5 | 6 | 500 | 469 | 420 | 188 |
| TPSD226*025R0200 | D | 22 | 25 | 5.5 | 6 | 200 | 866 | 775 | 346 |
| TPSE336*025R0175 | E | 33 | 25 | 8.3 | 6 | 175 | 971 | 868 | 388 |
| TPSE336*025R0200 | E | 33 | 25 | 8.3 | 6 | 200 | 908 | 812 | 363 |
| TPSE336*025R0300 | E | 33 | 25 | 8.3 | 6 | 300 | 742 | 663 | 297 |
| TPSD476*025R0250 | D | 47 | 25 | 11.8 | 6 | 250 | 775 | 693 | 310 |
| TPSV686*025R0095 | V | 68 | 25 | 17.0 | 8 | 95 | 1622 | 1451 | 649 |
| TPSV686*025R0150 | V | 68 | 25 | 17.0 | 10 | 150 | 1291 | 1155 | 516 |
| TPSV686*025R0300 | V | 68 | 25 | 17.0 | 10 | 300 | 913 | 816 | 365 |
| TPSC475*035R0600 | C | 4.7 | 35 | 1.6 | 6 | 600 | 428 | 383 | 171 |
| TPSD106*035R0300 | D | 10 | 35 | 3.5 | 6 | 300 | 707 | 632 | 283 |
| TPSE106*035R0200 | E | 10 | 35 | 3.5 | 6 | 200 | 908 | 812 | 363 |
| TPSC156*035R0450 | C | 15 | 35 | 5.3 | 6 | 450 | 494 | 442 | 198 |
| TPSD156*035R0300 | D | 15 | 35 | 5.3 | 6 | 300 | 707 | 632 | 283 |
| TPSD226*035R0400 | D | 22 | 35 | 7.7 | 6 | 400 | 612 | 548 | 245 |
| TPSE226*035R0200 | E | 22 | 35 | 7.7 | 6 | 200 | 908 | 812 | 363 |
| TPSE226*035R0300 | E | 22 | 35 | 7.7 | 6 | 300 | 742 | 663 | 297 |
| TPSD336*035R0300 | D | 33 | 35 | 11.6 | 6 | 300 | 707 | 632 | 283 |



The world's smallest surface mount Tantalum capacitor, small enough to create space providing room for ideas to grow.

TACmicrochip is a major breakthrough in miniaturization without reduction in performance.

It offers you the highest energy store in an 0603 or 0805 case size; enhanced high frequency operation through unique ESR performance with temperature and voltage stability.

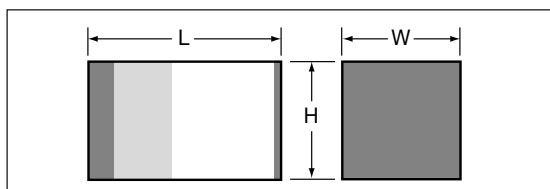

CASE DIMENSIONS: millimeters (inches)

| Code | EIA Code | W +0.20 (0.008) -0.10 (0.004) | L +0.25 (0.010) -0.15 (0.006) | H +0.20 (0.008) -0.10 (0.004) |
|------|----------|----------------------------------|----------------------------------|----------------------------------|
| L | 0603 | 0.85 (0.033) | 1.6 (0.063) | 0.85 (0.033) |
| R | 0805 | 1.35 (0.053) | 2.0 (0.079) | 1.35 (0.053) |

STANDARD CAPACITANCE RANGE (LETTER DENOTES CASE CODE)

| Capacitance | | Rated voltage at 85°C | | | | |
|-------------|------|-----------------------|----|----|------|-----|
| µF | Code | 2V | 3V | 4V | 6.3V | 10V |
| 0.47 | 474 | | | | | L |
| 0.68 | 684 | | | | | L |
| 1.0 | 105 | | | | L | L |
| 1.5 | 155 | | | L | L | L |
| 2.2 | 225 | | L | L | L | L |
| 3.3 | 335 | L | L | L | L | R |
| 4.7 | 475 | L | L | L | | R |
| 6.8 | 685 | L | L | | R | R |
| 10.0 | 106 | | | R | R | |
| 15.0 | 156 | | R | R | | |
| 22.0 | 226 | R | R | | | |
| 33.0 | 336 | R | R | R | | |
| 47.0 | 476 | R | R | | | |

- = Standard Range
- = Extended Range
- = Development Range

RATINGS AND PART NUMBER REFERENCE

| AVX Style | Case Size | Capacitance μF@120Hz | Leakage μA (Max) | DF % Max | ESR Max @100kHz |
|------------|-----------|-------------------------|------------------------|----------------|-----------------------|
| (2 volt) | | | | | |
| TAC | 0805 | 22 | 0.5 | 8 | 6 |
| TAC | 0805 | 33 | 0.7 | 8 | 6 |
| TAC | 0805 | 47 | 1.0 | 8 | 6 |
| (3 volt) | | | | | |
| TAC | 0805 | 15 | 0.5 | 8 | 6 |
| TAC | 0805 | 22 | 0.7 | 8 | 6 |
| TAC | 0805 | 33 | 1.0 | 8 | 6 |
| (4 volt) | | | | | |
| TAC | 0805 | 10 | 0.5 | 8 | 6 |
| TAC | 0805 | 15 | 0.6 | 8 | 6 |
| TAC | 0805 | 22 | 0.9 | 8 | 6 |
| (6.3 volt) | | | | | |
| TAC | 0805 | 6.8 | 0.5 | 8 | 6 |
| TAC | 0805 | 10 | 0.6 | 8 | 6 |
| TAC | 0805 | 15 | 0.9 | 8 | 6 |
| (10 volt) | | | | | |
| TAC | 0805 | 4.7 | 0.5 | 8 | 6 |
| TAC | 0805 | 6.8 | 0.7 | 8 | 6 |
| TAC | 0805 | 10 | 1.0 | 8 | 6 |

| AVX Style | Case Size | Capacitance μF@120Hz | Leakage μA (Max) | DF % Max | ESR Max @100kHz |
|------------|-----------|-------------------------|------------------------|----------------|-----------------------|
| (2 volt) | | | | | |
| TAC | 0603 | 3.3 | 0.5 | 6 | 10 |
| TAC | 0603 | 4.7 | 0.5 | 6 | 10 |
| TAC | 0603 | 6.8 | 0.5 | 6 | 10 |
| (3 volt) | | | | | |
| TAC | 0603 | 2.2 | 0.5 | 6 | 10 |
| TAC | 0603 | 3.3 | 0.5 | 6 | 10 |
| TAC | 0603 | 4.7 | 0.5 | 6 | 10 |
| (4 volt) | | | | | |
| TAC | 0603 | 1.5 | 0.5 | 6 | 10 |
| TAC | 0603 | 2.2 | 0.5 | 6 | 10 |
| TAC | 0603 | 3.3 | 0.5 | 6 | 10 |
| (6.3 volt) | | | | | |
| TAC | 0603 | 1.0 | 0.5 | 6 | 10 |
| TAC | 0603 | 1.5 | 0.5 | 6 | 10 |
| TAC | 0603 | 2.2 | 0.5 | 6 | 10 |
| (10 volt) | | | | | |
| TAC | 0603 | 0.47 | 0.5 | 6 | 12 |
| TAC | 0603 | 0.68 | 0.5 | 6 | 10 |
| TAC | 0603 | 1.0 | 0.5 | 6 | 10 |
| TAC | 0603 | 1.5 | 0.5 | 6 | 10 |

HOW TO ORDER

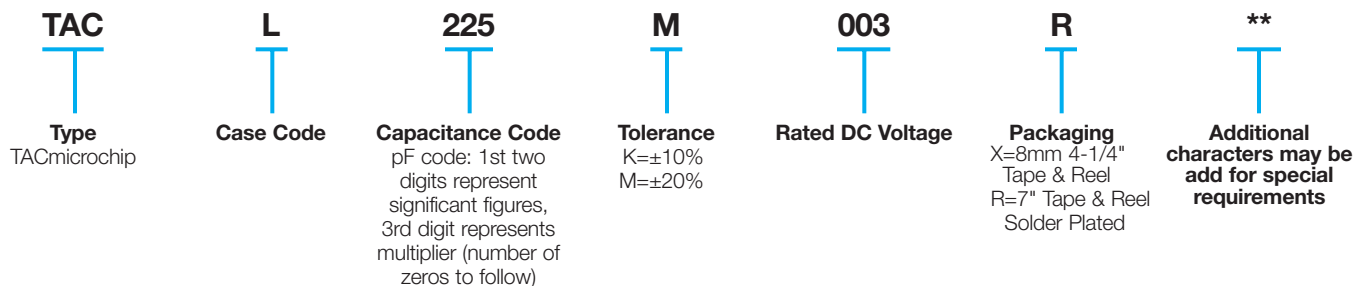

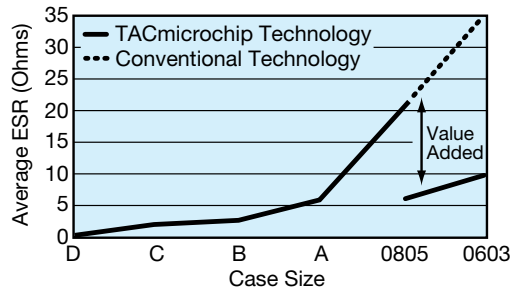

Figure 1.

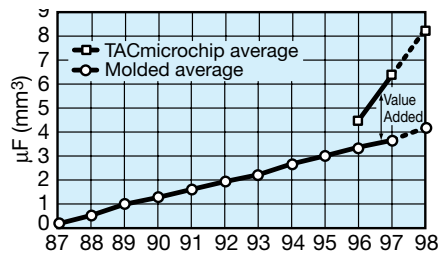
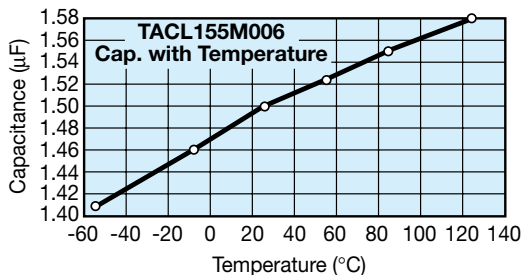
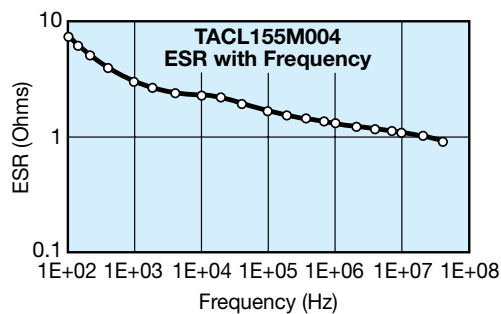
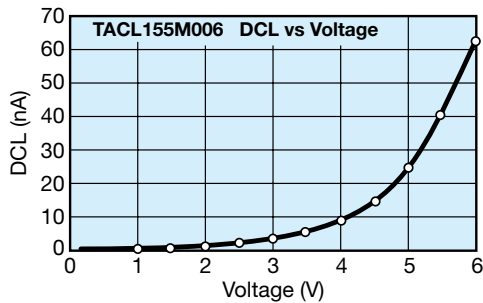

Figure 2.



Continued investment in R&D has resulted in AVX introducing revolutionary technology to the tantalum capacitor market.

The new TACmicrochip breaks new ground with the unique structure allowing 10 times more capacitance to be packaged in the 0603 case size than is possible with traditional technology.

Conventional molded tantalum technology results in an increase in ESR for each reduction in case size. Figure 1 shows a reduction in ESR performance of the TACmicrochip compared to the same case size if conventional technology were used.

Figure 2 shows a major leap forward in $\mu\text{F}/\text{mm}^3$ performance. The CV values offered in the 0603 cannot be achieved using conventional molded technology.

These features coupled with the temperature and voltage stability of tantalum, enable system designers to achieve equipment miniaturization without compromising performance, making TACmicrochip the optimum choice for size critical applications.

Enhancing Leakage Current & Battery Efficiency.

As portable electronic equipment becomes an integral part of everyday life, a key design focus becomes the ability to enhance and extend battery efficiency performance. Overall leakage current capability improvements are achieved using the unique TACmicrochip construction technology.

Enhanced ESR & High Frequency Operation.

The radically new construction technique used to manufacture the TACmicrochip eliminates a great many of the parasitic inductance resistance paths inherent in standard molded tantalum capacitors, giving the TACmicrochip an equivalent high frequency performance of larger sized product.

Volumetric Efficiency, Space & Weight Savings.

Achieving the industries highest available capacitance in 0603 case size allows high bulk energy storage with minimal use of valuable circuit board space. Add stable temperature and voltage performance and TACmicrochip becomes your preferred choice of miniature tantalum chip capacitor for size critical applications.

SURFACE MOUNTING CHIP SOLDERING

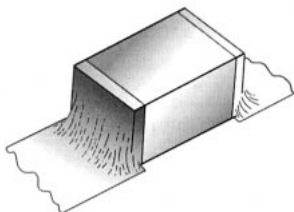

QUADS

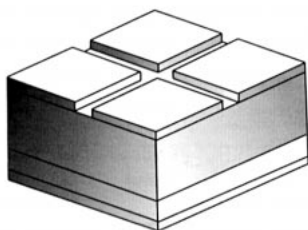

WIRE BONDING WITHIN THE SEMICONDUCTOR CHIP PACKAGE

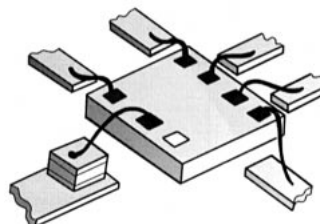

ARRAYS

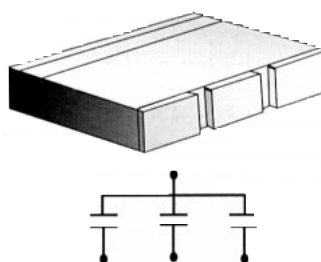

OTHER POSSIBLE CONFIGURATIONS FOR THE WAFER CAPACITOR

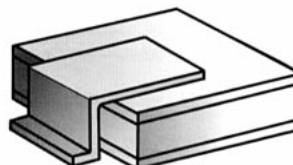
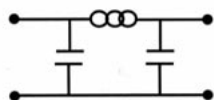
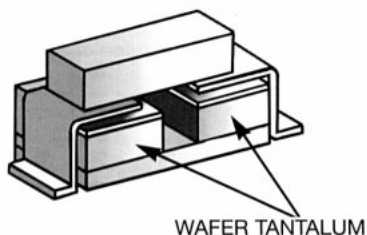
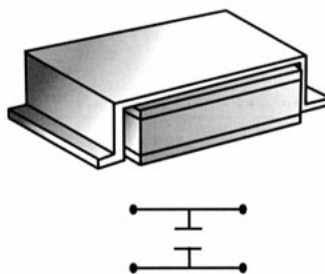
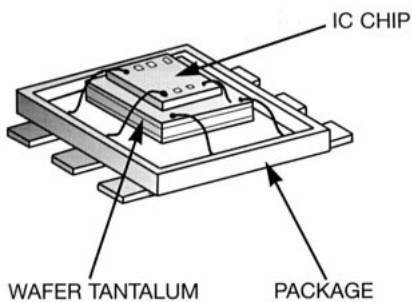

The manufacturing techniques used to make the TACmicrochip allow AVX to offer various custom options. Some examples of which are shown above. Please contact your local AVX sales office if you have a specific requirement.



The TAZ molded surface mount series is designed for use in applications utilizing either solder, conductive adhesive or thermal compression bonding techniques. Case sizes (A through H) are compatible with CWR06 pad layouts and are qualified as the CWR09 style.

The two styles are interchangeable per MIL-C-55365/4. Each chip is marked

with polarity, capacitance code and rated voltage. There are three termination finishes available: fused solder plated (standard) ("K" per MIL-C-55365), hot solder dipped ("C") and gold plated ("B"). In addition, the molding compound has been selected to meet the flammability requirements of UL94V-O and outgassing requirements of NASA SP-R-0022A.

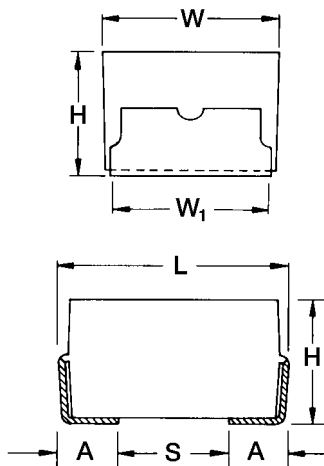

NOTE: For solder coated terminations add 0.38 (0.015) max. to length and height dimensions.

CASE DIMENSIONS: millimeters (inches)

| Case Code | Width W±0.38 (0.015) | Length L±0.38 (0.015) | Height H±0.38 (0.015) | Term. Width W ₁ | Term. Length A+0.13 (0.005) | "S" Min |
|-----------|-------------------------|--------------------------|--------------------------|---|--------------------------------|--------------|
| "Regular" | | | | | | |
| A | 1.27 (0.050) | 2.54 (0.100) | 1.27 (0.050) | 1.27±0.13 (0.050±0.005) | 0.76 (0.030) | 0.38 (0.015) |
| B | 1.27 (0.050) | 3.81 (0.150) | 1.27 (0.050) | 1.27±0.13 (0.050±0.005) | 0.76 (0.030) | 1.65 (0.065) |
| D | 2.54 (0.100) | 3.81 (0.150) | 1.27 (0.050) | 2.41+0.13/-0.25 (0.095+0.005/-0.010) | 0.76 (0.030) | 1.65 (0.065) |
| E | 2.54 (0.100) | 5.08 (0.200) | 1.27 (0.050) | 2.41+0.13/-0.25 (0.095+0.005/-0.010) | 0.76 (0.030) | 2.92 (0.115) |
| F | 3.43 (0.135) | 5.59 (0.220) | 1.78 (0.070) | 3.30±0.13 (0.130±0.005) | 0.76 (0.030) | 3.43 (0.135) |
| G | 2.79 (0.110) | 6.73 (0.265) | 2.79 (0.110) | 2.67±0.13 (0.105±0.005) | 1.27 (0.050) | 3.56 (0.140) |
| H | 3.81 (0.150) | 7.24 (0.285) | 2.79 (0.110) | 3.68+0.13/-0.51 (0.145+0.005/-0.020) | 1.27 (0.050) | 4.06 (0.160) |

Additional special case sizes are available. Contact your local sales office for details.

TECHNICAL SPECIFICATIONS

| Technical Data | | All technical data relate to an ambient temperature of +25°C | | | | | | | |
|------------------------------------|-----------|---|-----|----|----|----|----|----|----|
| Capacitance Range | | 0.1µF to 220µF | | | | | | | |
| Capacitance Tolerance | | ±20%; ±10% | | | | | | | |
| Rated Voltage (V _R) | ≅ +85°C: | 4 | 6.3 | 10 | 15 | 20 | 25 | 35 | 50 |
| Category Voltage (V _C) | ≅ +125°C: | 2.7 | 4 | 7 | 10 | 13 | 17 | 23 | 33 |
| Surge Voltage (V _S) | ≅ +85°C: | 5.2 | 8 | 13 | 20 | 26 | 33 | 46 | 65 |
| Surge Voltage (V _S) | ≅ +125°C: | 3.2 | 5 | 8 | 12 | 16 | 20 | 28 | 40 |
| Operating Temperature Range | | -55°C to +125°C | | | | | | | |
| Reliability | | 1% per 1000h at 85°C with a 0.1Ω/V series impedance, 60% confidence level | | | | | | | |
| Qualification | | MIL-C-55365/4 | | | | | | | |

HOW TO ORDER

| | | | | | | | | |
|--|---|---|--|--|--|--|---|---|
| TAZ ↓ (Professional Grade) Type | D ↓ Case Code See table on page 18 | 335 ↓ Capacitance Code pF code: 1st two digits represent significant figures, 3rd digit represents multiplier (number of zeros to follow) | M ↓ Tolerance J=±5% K=±10% M=±20% | 015 ↓ Rated DC Voltage | C ↓ Lead Configuration C = Chip X = Extended Range | R ↓ Packaging Consult page 44 for details | SZ* ↓ Manufacturing Routing and Failure Rate* S = Standard Z = Not applicable | 0000* ↓ Termination Finish* 0000 = Fused Solder Plated 0800 = Hot Solder Dipped 0900 = Gold Plated |
|--|---|---|--|--|--|--|---|---|

*Not applicable to European orders (other endings are assigned by the factory for special customer requirements)

MARKING

The positive end of body has videcon readable polarity bar marking along with the capacitance code and rated work voltage:

- Polarity Stripe (+)
- Capacitance Code
- Voltage Rating

The electrical and mechanical parameters shown on the TAZ series are general.

For specific circuit applications, special screening is available. Please contact AVX if you have special electrical or mechanical requirements.

TYPICAL LEAD FRAME MATERIAL THICKNESSES

- Lead Frame: Alloy 194
Thickness: 0.005±0.0002"
- 0000 - Fused Solder Plate: (60/40)
60-135 microinches nickel
300±75 microinches fused solder
- 0800 - Hot Solder Dipped: (60/40)
50-100 microinches nickel
Min. 60 microinches solder
- 0900 - Gold Plated:
35-100 microinches nickel
50-75 microinches gold

CAPACITANCE AND VOLTAGE RANGE (LETTER DENOTES CASE CODE)

| Capacitance | | Rated voltage (V _R) at 85°C | | | | | | | |
|-------------|------|---|-----|-----|-----|-----|-----|-----|-----|
| µF | Code | 4V | 6V | 10V | 15V | 20V | 25V | 35V | 50V |
| 0.1 | 104 | | | | | | | | A |
| 0.15 | 154 | | | | | | | | A |
| 0.22 | 224 | | | | | | | A | B |
| 0.33 | 334 | | | | | | A | B | B |
| 0.47 | 474 | | | | A | B A | B | | D |
| 0.68 | 684 | | | | | | | | |
| 1.0 | 105 | | A | A | A | B | B | D | E |
| 1.5 | 155 | | | | B | | D | D | F |
| 2.2 | 225 | A | | B A | | D B | E D | E | F |
| 3.3 | 335 | | B A | | D B | E D | E | F | G |
| 4.7 | 475 | B A | | D B | E D | E | F | G | H |
| 6.8 | 685 | | D B | E D | | F E | G F | H | |
| 10 | 106 | D B | E | D | F E | | G H | H | |
| 15 | 156 | E | D | F E | | G F | H | | |
| 22 | 226 | D | F E | E | G F | H G | H | | |
| 33 | 336 | F E | | G | H | | | | |
| 47 | 476 | | G | H F | | H | | | |
| 68 | 686 | G | H F | G | H | | | | |
| 100 | 107 | H F | | H | | | | | |
| 150 | 157 | G | | | | | | | |
| 220 | 227 | | H | | | | | | |

NOTE: TAZ Standard Range ratings are also available as CWR09 Military parts, see page 22.

- = Standard Range
- = Extended Range

RATINGS & PART NUMBER REFERENCE (Standard Range and Special Case Sizes Only)

| AVX Part No. | Case Size | Capacitance μF | DCL (μA) Max. | DF % Max. | ESR max. (Ω) @ 100 kHz |
|--|-----------|---------------------------|----------------------------|-----------|---------------------------------|
| 4 volt @ 85°C (2.5 volt @ 125°C) | | | | | |
| TAZA225(‡)004C* | A | 2.2 | 1.0 | 6 | 20.0 |
| TAZB475(‡)004C* | B | 4.7 | 1.0 | 6 | 10.0 |
| TAZD106(‡)004C* | D | 10.0 | 1.0 | 6 | 10.0 |
| TAZE156(‡)004C* | E | 15.0 | 1.0 | 8 | 5.0 |
| TAZF336(‡)004C* | R | 33.0 | 2.0 | 8 | 4.0 |
| TAZG686(‡)004C* | F | 68.0 | 3.0 | 10 | 2.0 |
| TAZH107(‡)004C* | H | 100.0 | 4.0 | 10 | 1.0 |
| 6.3 volt @ 85°C (4 volt @ 125°C) | | | | | |
| TAZA155(‡)006C* | A | 1.5 | 1.0 | 6 | 12.0 |
| TAZB335(‡)006C* | B | 3.3 | 1.0 | 6 | 12.0 |
| TAZD685(‡)006C* | D | 6.8 | 1.0 | 6 | 12.0 |
| TAZE106(‡)006C* | E | 10.0 | 1.0 | 6 | 6.0 |
| TAZF226(‡)006C* | F | 22.0 | 2.0 | 8 | 4.0 |
| TAZG476(‡)006C* | G | 47.0 | 3.0 | 10 | 2.0 |
| TAZH686(‡)006C* | H | 68.0 | 4.0 | 10 | 2.0 |
| 10 volt @ 85°C (6.3 volt @ 125°C) | | | | | |
| TAZA105(‡)010C* | A | 1.0 | 1.0 | 6 | 18.0 |
| TAZB225(‡)010C* | B | 2.2 | 1.0 | 6 | 12.0 |
| TAZD475(‡)010C* | D | 4.7 | 1.0 | 6 | 10.0 |
| TAZE685(‡)010C* | E | 6.8 | 1.0 | 6 | 4.0 |
| TAZF156(‡)010C* | F | 15.0 | 2.0 | 6 | 3.0 |
| TAZG336(‡)010C* | G | 33.0 | 3.0 | 10 | 3.0 |
| TAZH476(‡)010C* | H | 47.0 | 5.0 | 10 | 2.0 |
| 15 volt @ 85°C (10 volt @ 125°C) | | | | | |
| TAZA684(‡)015C* | A | 0.68 | 1.0 | 6 | 22.0 |
| TAZB155(‡)015C* | B | 1.5 | 1.0 | 6 | 15.0 |
| TAZD335(‡)015C* | D | 3.3 | 1.0 | 6 | 10.0 |
| TAZE475(‡)015C* | E | 4.7 | 1.0 | 6 | 6.0 |
| TAZF106(‡)015C* | F | 10.0 | 2.0 | 6 | 5.0 |
| TAZG226(‡)015C* | G | 22.0 | 4.0 | 8 | 3.0 |
| TAZH336(‡)015C* | H | 33.0 | 5.0 | 8 | 2.0 |
| 20 volt @ 85°C (13 volt @ 125°C) | | | | | |
| TAZA474(‡)020C* | A | 0.47 | 1.0 | 6 | 20.0 |
| TAZB684(‡)020C* | B | 0.68 | 1.0 | 6 | 15.0 |
| TAZB105(‡)020C* | B | 1.0 | 1.0 | 6 | 15.0 |
| TAZD225(‡)020C* | D | 2.2 | 1.0 | 6 | 10.0 |
| TAZE335(‡)020C* | E | 3.3 | 1.0 | 6 | 8.0 |
| TAZF685(‡)020C* | F | 6.8 | 2.0 | 6 | 5.0 |
| TAZG156(‡)020C* | G | 15.0 | 3.0 | 6 | 3.0 |
| TAZH226(‡)020C* | H | 22.0 | 4.0 | 6 | 2.0 |

| AVX Part No. | Case Size | Capacitance μF | DCL (μA) Max. | DF % Max. | ESR max. (Ω) @ 100 kHz |
|---|-----------|---------------------------|----------------------------|-----------|---------------------------------|
| 25 volt @ 85°C (16 volt @ 125°C) | | | | | |
| TAZA334(‡)025C* | A | 0.33 | 1.0 | 6 | 25.0 |
| TAZB684(‡)025C* | B | 0.68 | 1.0 | 6 | 15.0 |
| TAZD155(‡)025C* | D | 1.5 | 1.0 | 6 | 10.0 |
| TAZE225(‡)025C* | E | 2.2 | 1.0 | 6 | 8.0 |
| TAZF475(‡)025C* | F | 4.7 | 2.0 | 6 | 6.0 |
| TAZG685(‡)025C* | G | 6.8 | 2.0 | 6 | 4.0 |
| TAZH106(‡)025C* | G | 10.0 | 3.0 | 6 | 3.0 |
| TAZH156(‡)025C* | H | 15.0 | 4.0 | 6 | 2.0 |
| 35 volt @ 85°C (23 volt @ 125°C) | | | | | |
| TAZA224(‡)035C* | A | 0.22 | 1.0 | 6 | 25.0 |
| TAZB474(‡)035C* | B | 0.47 | 1.0 | 6 | 20.0 |
| TAZD105(‡)035C* | D | 1.0 | 1.0 | 6 | 12.0 |
| TAZE155(‡)035C* | E | 1.5 | 1.0 | 6 | 6.0 |
| TAZF335(‡)035C* | F | 3.3 | 1.0 | 6 | 6.0 |
| TAZG475(‡)035C* | G | 4.7 | 2.0 | 6 | 3.0 |
| TAZH685(‡)035C* | H | 6.8 | 3.0 | 6 | 3.0 |
| 50 volt @ 85°C (33 volt @ 125°C) | | | | | |
| TAZA104(‡)050C* | A | 0.10 | 1.0 | 6 | 30.0 |
| TAZA154(‡)050C* | A | 0.15 | 1.0 | 6 | 30.0 |
| TAZB224(‡)050C* | B | 0.22 | 1.0 | 6 | 25.0 |
| TAZB334(‡)050C* | B | 0.33 | 1.0 | 6 | 25.0 |
| TAZD684(‡)050C* | D | 0.68 | 1.0 | 6 | 20.0 |
| TAZE105(‡)050C* | E | 1.0 | 1.0 | 6 | 12.0 |
| TAZF155(‡)050C* | F | 1.5 | 1.0 | 6 | 10.0 |
| TAZF225(‡)050C* | F | 2.2 | 2.0 | 6 | 6.0 |
| TAZG335(‡)050C* | G | 3.3 | 2.0 | 6 | 4.0 |
| TAZH475(‡)050C* | H | 4.7 | 3.0 | 6 | 2.0 |

All technical data relates to an ambient temperature of +25°C. Capacitance and DF are measured at 120 Hz, 0.5V RMS with a maximum DC bias of 2.2 volts. DCL is measured at rated voltage after 5 minutes.

‡ Insert J for $\pm 5\%$ tolerance, K for $\pm 10\%$, M for $\pm 20\%$

* Insert letter for packing option. See ordering information on page 19.

The electrical and mechanical parameters shown on the TAZ series are general. For special circuit requirements, application specific testing is available. Please contact your local AVX sales office if you have special electrical or mechanical requirements.

DCL, DF and ESR limits are general information only. Contact AVX if your application requires lower or tighter limits.

TAZ Series

Extended Range



RATINGS & PART NUMBER REFERENCE

| AVX Part No. | Case Size | Capacitance μF | DCL (μA) Max. | DF % Max. | ESR max. (Ω) @ 100 kHz |
|-----------------|-----------|---------------------------|----------------------------|-----------|---------------------------------|
| 4 volt | | | | | |
| TAZA475(‡)004X* | A | 4.7 | 1 | 6 | 20 |
| TAZB106(‡)004X* | B | 10 | 1 | 6 | 10 |
| TAZD226(‡)004X* | D | 22 | 1 | 8 | 10 |
| TAZE336(‡)004X* | E | 33 | 2 | 8 | 5 |
| TAZF107(‡)004X* | F | 100 | 4 | 10 | 4 |
| TAZG157(‡)004X* | G | 150 | 6 | 10 | 2 |
| 6 volt | | | | | |
| TAZA335(‡)006X* | A | 3.3 | 1 | 6 | 18 |
| TAZB685(‡)006X* | B | 6.8 | 1 | 6 | 12 |
| TAZD156(‡)006X* | D | 15 | 1 | 6 | 10 |
| TAZE226(‡)006X* | E | 22 | 2 | 6 | 4 |
| TAZF686(‡)006X* | F | 68 | 4 | 8 | 4 |
| TAZG107(‡)006X* | G | 100 | 6 | 10 | 2 |
| TAZH227(‡)006X* | H | 220 | 10 | 10 | 1 |
| 10 volt | | | | | |
| TAZA225(‡)010X* | A | 2.2 | 1 | 6 | 20 |
| TAZB475(‡)010X* | B | 4.7 | 1 | 6 | 12 |
| TAZD685(‡)010X* | D | 6.8 | 1 | 6 | 8 |
| TAZD106(‡)010X* | D | 10 | 1 | 6 | 10 |
| TAZE156(‡)010X* | E | 15 | 2 | 6 | 4 |
| TAZE226(‡)010X* | E | 22 | 3 | 6 | 4 |
| TAZF476(‡)010X* | F | 47 | 4 | 8 | 3 |
| TAZG686(‡)010X* | G | 68 | 6 | 10 | 2 |
| TAZH107(‡)010X* | H | 100 | 10 | 10 | 1 |

| AVX Part No. | Case Size | Capacitance μF | DCL (μA) Max. | DF % Max. | ESR max. (Ω) @ 100 kHz |
|-----------------|-----------|---------------------------|----------------------------|-----------|---------------------------------|
| 15 volt | | | | | |
| TAZA105(‡)015X* | A | 1 | 1 | 6 | 22 |
| TAZB335(‡)015X* | B | 3.3 | 1 | 6 | 12 |
| TAZD475(‡)015X* | D | 4.7 | 1 | 6 | 10 |
| TAZE106(‡)015X* | E | 10 | 2 | 6 | 6 |
| TAZF226(‡)015X* | F | 22 | 3 | 6 | 5 |
| TAZH686(‡)015X* | H | 68 | 10 | 8 | 2 |
| 20 volt | | | | | |
| TAZA684(‡)020X* | A | 0.68 | 1 | 6 | 22 |
| TAZB225(‡)020X* | B | 2.2 | 1 | 6 | 12 |
| TAZD335(‡)020X* | D | 3.3 | 1 | 6 | 10 |
| TAZE475(‡)020X* | E | 4.7 | 1 | 6 | 8 |
| TAZF685(‡)020X* | E | 6.8 | 2 | 6 | 8 |
| TAZF156(‡)020X* | F | 15 | 3 | 6 | 4 |
| TAZG226(‡)020X* | G | 22 | 4 | 8 | 3 |
| TAZH476(‡)020X* | H | 47 | 10 | 8 | 2 |
| 25 volt | | | | | |
| TAZB105(‡)025X* | B | 1 | 1 | 6 | 12 |
| TAZD225(‡)025X* | D | 2.2 | 1 | 6 | 10 |
| TAZE335(‡)025X* | E | 3.3 | 1 | 6 | 8 |
| TAZF685(‡)025X* | F | 6.8 | 2 | 6 | 6 |
| TAZH226(‡)025X* | H | 22 | 6 | 8 | 2 |
| 35 volt | | | | | |
| TAZH106(‡)035X* | H | 10 | 4 | 8 | 2 |

‡ Insert J for $\pm 5\%$ tolerance, K for $\pm 10\%$, M for $\pm 20\%$

* Insert letter for packing option. See ordering information on page 19.

All technical data relates to an ambient temperature of $+25^{\circ}\text{C}$. Capacitance and DF are measured at 120 Hz, 0.5V RMS with a maximum DC bias of 2.2 volts. DCL is measured at rated voltage after 5 minutes.

The electrical and mechanical parameters shown on the TAZ series are general.

For special circuit requirements, application specific testing is available. Please contact your local AVX sales office if you have special electrical or mechanical requirements.

DCL, DF and ESR limits are general information only. Contact AVX if your application requires lower or tighter limits.

NOTE: Voltage ratings are minimum values. We reserve the right to supply higher voltage ratings in the same case size, to the same reliability standards.

CWR09 Series



MIL-C-55365/4

MARKING

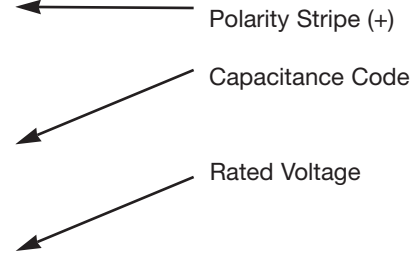
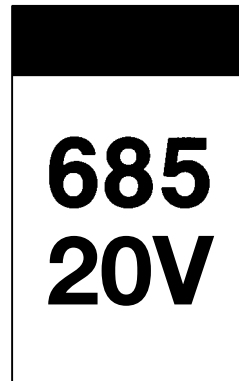

HOW TO ORDER (MIL-C-55365/4)

| CWR09 | F | B | 225 | K | M | A | \TR |
|-------------|--|---|-------------------------|---|---|--|---|
| Type | Voltage C=4 D=6 F=10 H=15 J=20 K=25 M=35 N=50 | Termination Finish B=Gold Plated C=Hot Solder Dipped K=Solder Fused | Capacitance Code | Tolerance J=±5% K=±10% M=±20% | Failure Rate Exponential: M=1%/1000 hours P=0.1%/1000 hours R=0.01%/1000 hours S=0.001%/1000 hours Weibull: B=0.1%/1000 hours C=0.01%/1000 hours | Optional Surge Current A=10 cycles at 25°C B=10 cycles at -55°C and +85°C | Packaging Bulk (Standard if nothing is specified in this position) \TR=7" Tape & Reel \TR13=13" Tape & Reel \W=Waffle Pack |

NOTES: CWR09 is fully interchangeable with CWR06.
 Case Sizes correspond to TAZ A through H.
 Packaging information can be found on page 44.



ELECTRICAL RATINGS FOR CWR09 CAPACITORS

| MIL-C-55365/4 Part Number (See Note) | Case Size★ | Rated Voltage (85°C) (volts) | Capacitance (nom.) (μF) | DC Leakage (max.) | | | Dissipation Factor (max.) | | | Max. ESR 100 kHz +25°C Style CWR09 (Ohms) |
|---|---------------|---------------------------------------|-------------------------------|-------------------|---------------|----------------|---------------------------|------------------|--------------|--|
| | | | | +25°C (μA) | +85°C (μA) | +125°C (μA) | +25°C (%) | +85/125°C (%) | -55°C (%) | |
| CWR09C*225†@Δ□ | A | 4 | 2.2 | 1.0 | 10 | 12 | 6 | 8 | 8 | 8.0 |
| CWR09C*475†@Δ□ | B | 4 | 4.7 | 1.0 | 10 | 12 | 6 | 8 | 8 | 8.0 |
| CWR09C*685†@Δ□ | C | 4 | 6.8 | 1.0 | 10 | 12 | 6 | 8 | 8 | 5.5 |
| CWR09C*106†@Δ□ | D | 4 | 10.0 | 1.0 | 10 | 12 | 8 | 8 | 10 | 4.0 |
| CWR09C*156†@Δ□ | E | 4 | 15.0 | 1.0 | 10 | 12 | 8 | 10 | 12 | 3.5 |
| CWR09C*336†@Δ□ | F | 4 | 33.0 | 2.0 | 20 | 24 | 8 | 10 | 12 | 2.2 |
| CWR09C*686†@Δ□ | G | 4 | 68.0 | 3.0 | 30 | 36 | 10 | 12 | 12 | 1.1 |
| CWR09C*107†@Δ□ | H | 4 | 100.0 | 4.0 | 40 | 48 | 10 | 12 | 12 | 0.9 |
| CWR09D*155†@Δ□ | A | 6 | 1.5 | 1.0 | 10 | 12 | 6 | 8 | 8 | 8.0 |
| CWR09D*335†@Δ□ | B | 6 | 3.3 | 1.0 | 10 | 12 | 6 | 8 | 8 | 8.0 |
| CWR09D*475†@Δ□ | C | 6 | 4.7 | 1.0 | 10 | 12 | 6 | 8 | 8 | 5.5 |
| CWR09D*685†@Δ□ | D | 6 | 6.8 | 1.0 | 10 | 12 | 6 | 8 | 8 | 4.5 |
| CWR09D*106†@Δ□ | E | 6 | 10.0 | 1.0 | 10 | 12 | 8 | 10 | 12 | 3.5 |
| CWR09D*226†@Δ□ | F | 6 | 22.0 | 2.0 | 20 | 24 | 8 | 10 | 12 | 2.2 |
| CWR09D*476†@Δ□ | G | 6 | 47.0 | 3.0 | 30 | 36 | 10 | 12 | 12 | 1.1 |
| CWR09D*686†@Δ□ | H | 6 | 68.0 | 4.0 | 40 | 48 | 10 | 12 | 12 | 0.9 |
| CWR09F*105†@Δ□ | A | 10 | 1.0 | 1.0 | 10 | 12 | 6 | 8 | 8 | 10.0 |
| CWR09F*225†@Δ□ | B | 10 | 2.2 | 1.0 | 10 | 12 | 6 | 8 | 8 | 8.0 |
| CWR09F*335†@Δ□ | C | 10 | 3.3 | 1.0 | 10 | 12 | 6 | 8 | 8 | 5.5 |
| CWR09F*475†@Δ□ | D | 10 | 4.7 | 1.0 | 10 | 12 | 6 | 8 | 8 | 4.5 |
| CWR09F*685†@Δ□ | E | 10 | 6.8 | 1.0 | 10 | 12 | 6 | 8 | 8 | 3.5 |
| CWR09F*156†@Δ□ | F | 10 | 15.0 | 2.0 | 20 | 24 | 8 | 8 | 10 | 2.5 |
| CWR09F*336†@Δ□ | G | 10 | 33.0 | 3.0 | 30 | 36 | 10 | 12 | 12 | 1.1 |
| CWR09F*476†@Δ□ | H | 10 | 47.0 | 5.0 | 50 | 60 | 10 | 12 | 12 | 0.9 |
| CWR09H*684†@Δ□ | A | 15 | 0.68 | 1.0 | 10 | 12 | 6 | 8 | 8 | 12.0 |
| CWR09H*155†@Δ□ | B | 15 | 1.5 | 1.0 | 10 | 12 | 6 | 8 | 8 | 8.0 |
| CWR09H*225†@Δ□ | C | 15 | 2.2 | 1.0 | 10 | 12 | 6 | 8 | 8 | 5.5 |
| CWR09H*335†@Δ□ | D | 15 | 3.3 | 1.0 | 10 | 12 | 6 | 8 | 8 | 5.0 |
| CWR09H*475†@Δ□ | E | 15 | 4.7 | 1.0 | 10 | 12 | 6 | 8 | 8 | 4.0 |
| CWR09H*106†@Δ□ | F | 15 | 10.0 | 2.0 | 20 | 24 | 6 | 8 | 8 | 2.5 |
| CWR09H*226†@Δ□ | G | 15 | 22.0 | 4.0 | 40 | 48 | 8 | 8 | 10 | 1.1 |
| CWR09H*336†@Δ□ | H | 15 | 33.0 | 5.0 | 50 | 60 | 8 | 8 | 10 | 0.9 |
| CWR09J*474†@Δ□ | A | 20 | 0.47 | 1.0 | 10 | 12 | 6 | 8 | 8 | 14.0 |
| CWR09J*684†@Δ□ | B | 20 | 0.68 | 1.0 | 10 | 12 | 6 | 8 | 8 | 10.0 |
| CWR09J*105†@Δ□ | B | 20 | 1.0 | 1.0 | 10 | 12 | 6 | 8 | 8 | 12.0 |
| CWR09J*155†@Δ□ | C | 20 | 1.5 | 1.0 | 10 | 12 | 6 | 8 | 8 | 6.0 |
| CWR09J*225†@Δ□ | D | 20 | 2.2 | 1.0 | 10 | 12 | 6 | 8 | 8 | 5.0 |
| CWR09J*335†@Δ□ | E | 20 | 3.3 | 1.0 | 10 | 12 | 6 | 8 | 8 | 4.0 |
| CWR09J*685†@Δ□ | F | 20 | 6.8 | 2.0 | 20 | 24 | 6 | 8 | 8 | 2.4 |
| CWR09J*156†@Δ□ | G | 20 | 15.0 | 3.0 | 30 | 36 | 6 | 8 | 8 | 1.1 |
| CWR09J*226†@Δ□ | H | 20 | 22.0 | 4.0 | 40 | 48 | 6 | 8 | 8 | 0.9 |

★ = Termination Finish
 B = Gold Plated
 C = Hot Solder Dipped
 K = Solder Fused

† = Tolerance Code
 J = ±5%
 K = ±10%
 M = ±20%

@ = Failure Rate Level
 Exponential:
 M = 1.0% per 1000 hours
 P = 0.1% per 1000 hours
 R = 0.01% per 1000 hours
 S = 0.001% per 1000 hours
 Weibull:
 B = 0.1% per 1000 hours
 C = 0.01% per 1000 hours

Δ = Optional Surge Current
 A = 10 cycles at 25°C
 B = 10 cycles at -55°C
 and +85°C

□ = Packaging
 Bulk Standard
 \TR=7" Tape & Reel
 \TR13=13" Tape & Reel
 W=Waffle Pack

★ The C case has limited availability. Where possible D case should be substituted.

ELECTRICAL RATINGS FOR CWR09 CAPACITORS

| MIL-C-55365/4 Part Number (See Note) | Case Size★ | Rated Voltage (85°C) (volts) | Capacitance (nom.) (μF) | DC Leakage (max.) | | | Dissipation Factor (max.) | | | Max. ESR 100 kHz +25°C Style CWR09 (Ohms) |
|--------------------------------------|------------|------------------------------|-------------------------|-------------------|------------|-------------|---------------------------|---------------|-----------|---|
| | | | | +25°C (μA) | +85°C (μA) | +125°C (μA) | +25°C (%) | +85/125°C (%) | -55°C (%) | |
| CWR09K*334†@Δ□ | A | 25 | 0.33 | 1.0 | 10 | 12 | 6 | 8 | 8 | 15.0 |
| CWR09K*684†@Δ□ | B | 25 | 0.68 | 1.0 | 10 | 12 | 6 | 8 | 8 | 7.5 |
| CWR09K*105†@Δ□ | C | 25 | 1.0 | 1.0 | 10 | 12 | 6 | 8 | 8 | 6.5 |
| CWR09K*155†@Δ□ | D | 25 | 1.5 | 1.0 | 10 | 12 | 6 | 8 | 8 | 6.5 |
| CWR09K*225†@Δ□ | E | 25 | 2.2 | 1.0 | 10 | 12 | 6 | 8 | 8 | 3.5 |
| CWR09K*475†@Δ□ | F | 25 | 4.7 | 2.0 | 20 | 24 | 6 | 8 | 8 | 2.5 |
| CWR09K*685†@Δ□ | G | 25 | 6.8 | 2.0 | 20 | 24 | 6 | 8 | 8 | 1.2 |
| CWR09K*106†@Δ□ | G | 25 | 10.0 | 3.0 | 30 | 36 | 6 | 8 | 8 | 1.4 |
| CWR09K*156†@Δ□ | H | 25 | 15.0 | 4.0 | 40 | 48 | 6 | 8 | 8 | 1.0 |
| CWR09M*224†@Δ□ | A | 35 | 0.22 | 1.0 | 10 | 12 | 6 | 8 | 8 | 18.0 |
| CWR09M*474†@Δ□ | B | 35 | 0.47 | 1.0 | 10 | 12 | 6 | 8 | 8 | 10.0 |
| CWR09M*684†@Δ□ | C | 35 | 0.68 | 1.0 | 10 | 12 | 6 | 8 | 8 | 8.0 |
| CWR09M*105†@Δ□ | D | 35 | 1.0 | 1.0 | 10 | 12 | 6 | 8 | 8 | 6.5 |
| CWR09M*155†@Δ□ | E | 35 | 1.5 | 1.0 | 10 | 12 | 6 | 8 | 8 | 4.5 |
| CWR09M*335†@Δ□ | F | 35 | 3.3 | 1.0 | 10 | 12 | 6 | 8 | 8 | 2.5 |
| CWR09M*475†@Δ□ | G | 35 | 4.7 | 2.0 | 20 | 24 | 6 | 8 | 8 | 1.5 |
| CWR09M*685†@Δ□ | H | 35 | 6.8 | 3.0 | 30 | 36 | 6 | 8 | 8 | 1.3 |
| CWR09N*104†@Δ□ | A | 50 | 0.10 | 1.0 | 10 | 12 | 6 | 8 | 8 | 22.0 |
| CWR09N*154†@Δ□ | A | 50 | 0.15 | 1.0 | 10 | 12 | 6 | 8 | 8 | 17.0 |
| CWR09N*224†@Δ□ | B | 50 | 0.22 | 1.0 | 10 | 12 | 6 | 8 | 8 | 14.0 |
| CWR09N*334†@Δ□ | B | 50 | 0.33 | 1.0 | 10 | 12 | 6 | 8 | 8 | 12.0 |
| CWR09N*474†@Δ□ | C | 50 | 0.47 | 1.0 | 10 | 12 | 6 | 8 | 8 | 8.0 |
| CWR09N*684†@Δ□ | D | 50 | 0.68 | 1.0 | 10 | 12 | 6 | 8 | 8 | 7.0 |
| CWR09N*105†@Δ□ | E | 50 | 1.0 | 1.0 | 10 | 12 | 6 | 8 | 8 | 6.0 |
| CWR09N*155†@Δ□ | F | 50 | 1.5 | 1.0 | 10 | 12 | 6 | 8 | 8 | 4.0 |
| CWR09N*225†@Δ□ | F | 50 | 2.2 | 2.0 | 20 | 24 | 6 | 8 | 8 | 2.5 |
| CWR09N*335†@Δ□ | G | 50 | 3.3 | 2.0 | 20 | 24 | 6 | 8 | 8 | 2.0 |
| CWR09N*475†@Δ□ | H | 50 | 4.7 | 3.0 | 30 | 36 | 6 | 8 | 8 | 1.5 |

NOTE: To complete the MIL-C-55365/4 Part Number, additional information must be added:

Contact your local AVX sales office for latest qualification status.

* = Termination Finish
 B = Gold Plated
 C = Hot Solder Dipped
 K = Solder Fused

† = Tolerance Code
 J = ±5%
 K = ±10%
 M = ±20%

@ = Failure Rate Level
 Exponential:
 M = 1.0% per 1000 hours
 P = 0.1% per 1000 hours
 R = 0.01% per 1000 hours
 S = 0.001% per 1000 hours

Δ = Optional Surge Current
 A = 10 cycles at 25°C
 B = 10 cycles at -55°C and +85°C

□ = Packaging
 Bulk Standard
 \TR=7" Tape & Reel
 \TR13=13" Tape & Reel
 \W=Waffle Pack

★ The C case has limited availability. Where possible D case should be substituted.

Weibull:
 B = 0.1% per 1000 hours
 C = 0.01% per 1000 hours

CWR11 Style

MIL-C-55365/8



MARKING

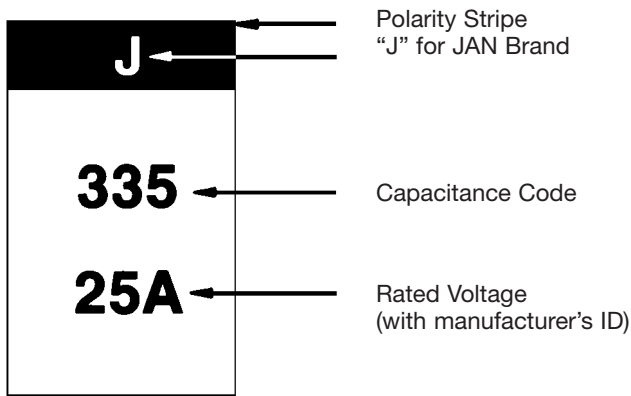

CASE DIMENSIONS: millimeters (inches)

| Case Code | W | L | H | P | | H ₂ (min) |
|-----------|--------------------------|--------------------------|--------------------------|----------------|----------------|----------------------|
| | | | | ±0.1 (±0.004) | ±0.3 (±0.012) | |
| A | 1.6±0.2 (0.063±0.008) | 3.2±0.2 (0.126±0.008) | 1.6±0.2 (0.063±0.008) | 1.2 (0.047) | 0.8 (0.031) | 0.7 (0.028) |
| B | 2.8±0.2 (0.110±0.008) | 3.5±0.2 (0.138±0.008) | 1.9±0.2 (0.075±0.008) | 2.2 (0.087) | 0.8 (0.031) | 0.7 (0.028) |
| C | 3.2±0.3 (0.126±0.012) | 6.0±0.3 (0.236±0.012) | 2.5±0.3 (0.098±0.012) | 2.2 (0.087) | 1.3 (0.051) | 1.0 (0.039) |
| D | 4.3±0.3 (0.169±0.012) | 7.3±0.3 (0.287±0.012) | 2.8±0.3 (0.110±0.012) | 2.4 (0.094) | 1.3 (0.051) | 1.0 (0.039) |

HOW TO ORDER (MIL-C-55365/8)

CWR11

Type

F

Voltage

C=4
D=6
F=10
H=15
J=20
K=25
M=35
N=50

A

Termination Finish

B=Gold Plated
C=Hot Solder Dipped
K=Solder Fused

225

Capacitance Code

K

Tolerance

J=±5%
K=±10%
M=±20%

M

Failure Rate

Exponential:
M=1%/1000 hours
P=0.1%/1000 hours
R=0.01%/1000 hours
S=0.001%/1000 hours

Weibull:
B=0.1%/1000 hours
C=0.01%/1000 hours
D=0.001%/1000 hours

A

Optional Surge Current

A=10 cycles at 25°C
B=10 cycles at -55°C and +85°C

\TR

Packaging

Bulk (Standard if nothing is specified in this position)
\TR=7" Tape & Reel
\TR13=13" Tape & Reel
W=Waffle Pack

ELECTRICAL RATINGS FOR CWR11 CAPACITORS

| MIL-C-55365/8 Part Number (See Note) | Case Size | Rated Voltage (85°C) (volts) | Capacitance (nom.) (μF) | DC Leakage (max.) | | | Dissipation Factor (max.) | | | Max. ESR 100 kHz (Ω) |
|---|--------------|---------------------------------------|-------------------------------|-------------------|---------------|----------------|---------------------------|------------------|--------------|-------------------------------|
| | | | | +25°C (μA) | +85°C (μA) | +125°C (μA) | +25°C (%) | +85/125°C (%) | -55°C (%) | |
| CWR11D*155†@Δ□ | A | 6 | 1.5 | 0.5 | 5.0 | 6.0 | 6 | 9 | 9 | 8.0 |
| CWR11D*225†@Δ□ | A | 6 | 2.2 | 0.5 | 5.0 | 6.0 | 6 | 6 | 9 | 8.0 |
| CWR11D*335†@Δ□ | A | 6 | 3.3 | 0.5 | 5.0 | 6.0 | 6 | 9 | 9 | 8.0 |
| CWR11D*475†@Δ□ | B | 6 | 4.7 | 0.5 | 5.0 | 6.0 | 6 | 9 | 9 | 5.5 |
| CWR11D*685†@Δ□ | B | 6 | 6.8 | 0.5 | 5.0 | 6.0 | 6 | 6 | 9 | 4.5 |
| CWR11D*106†@Δ□ | B | 6 | 10.0 | 0.6 | 6.0 | 7.2 | 6 | 9 | 9 | 3.5 |
| CWR11D*156†@Δ□ | C | 6 | 15.0 | 0.9 | 9.0 | 10.8 | 6 | 6 | 9 | 3.0 |
| CWR11D*226†@Δ□ | C | 6 | 22.0 | 1.4 | 14.0 | 16.8 | 6 | 9 | 9 | 2.2 |
| CWR11D*476†@Δ□ | D | 6 | 47.0 | 2.8 | 28.0 | 33.6 | 6 | 6 | 9 | 1.1 |
| CWR11F*105†@Δ□ | A | 10 | 1.0 | 0.5 | 5.0 | 6.0 | 4 | 6 | 6 | 10.0 |
| CWR11F*155†@Δ□ | A | 10 | 1.5 | 0.5 | 5.0 | 6.0 | 6 | 6 | 9 | 8.0 |
| CWR11F*225†@Δ□ | A | 10 | 2.2 | 0.5 | 5.0 | 6.0 | 6 | 9 | 9 | 8.0 |
| CWR11F*335†@Δ□ | B | 10 | 3.3 | 0.5 | 5.0 | 6.0 | 6 | 9 | 9 | 5.5 |
| CWR11F*475†@Δ□ | B | 10 | 4.7 | 0.5 | 5.0 | 6.0 | 6 | 9 | 9 | 4.5 |
| CWR11F*685†@Δ□ | B | 10 | 6.8 | 0.7 | 7.0 | 8.4 | 6 | 9 | 9 | 3.5 |
| CWR11F*156†@Δ□ | C | 10 | 15.0 | 1.5 | 15.0 | 18.0 | 6 | 6 | 9 | 2.5 |
| CWR11F*336†@Δ□ | D | 10 | 33.0 | 3.3 | 33.0 | 39.6 | 6 | 6 | 9 | 1.1 |
| CWR11H*684†@Δ□ | A | 15 | 0.68 | 0.5 | 5.0 | 6.0 | 4 | 6 | 6 | 12.0 |
| CWR11H*105†@Δ□ | A | 15 | 1.0 | 0.5 | 5.0 | 6.0 | 4 | 6 | 9 | 10.0 |
| CWR11H*155†@Δ□ | A | 15 | 1.5 | 0.5 | 5.0 | 6.0 | 6 | 9 | 9 | 8.0 |
| CWR11H*225†@Δ□ | B | 15 | 2.2 | 0.5 | 5.0 | 6.0 | 6 | 9 | 9 | 5.5 |
| CWR11H*335†@Δ□ | B | 15 | 3.3 | 0.5 | 5.0 | 6.0 | 6 | 8 | 9 | 5.0 |
| CWR11H*475†@Δ□ | B | 15 | 4.7 | 0.7 | 7.0 | 8.4 | 6 | 9 | 9 | 4.0 |
| CWR11H*106†@Δ□ | C | 15 | 10.0 | 1.6 | 16.0 | 19.2 | 6 | 8 | 9 | 2.5 |
| CWR11H*226†@Δ□ | D | 15 | 22.0 | 3.3 | 33.0 | 39.6 | 6 | 8 | 9 | 1.1 |
| CWR11J*474†@Δ□ | A | 20 | 0.47 | 0.5 | 5.0 | 6.0 | 4 | 6 | 6 | 14.0 |
| CWR11J*684†@Δ□ | A | 20 | 0.68 | 0.5 | 5.0 | 6.0 | 4 | 6 | 6 | 12.0 |
| CWR11J*105†@Δ□ | A | 20 | 1.0 | 0.5 | 5.0 | 6.0 | 4 | 6 | 6 | 10.0 |
| CWR11J*155†@Δ□ | B | 20 | 1.5 | 0.5 | 5.0 | 6.0 | 6 | 9 | 9 | 6.0 |
| CWR11J*225†@Δ□ | B | 20 | 2.2 | 0.5 | 5.0 | 6.0 | 6 | 8 | 9 | 5.0 |
| CWR11J*335†@Δ□ | B | 20 | 3.3 | 0.7 | 7.0 | 8.4 | 6 | 9 | 9 | 4.0 |
| CWR11J*475†@Δ□ | C | 20 | 4.7 | 1.0 | 10.0 | 12.0 | 6 | 8 | 9 | 3.0 |
| CWR11J*685†@Δ□ | C | 20 | 6.8 | 1.4 | 14.0 | 16.8 | 6 | 9 | 9 | 2.4 |
| CWR11J*156†@Δ□ | D | 20 | 15.0 | 3.0 | 30.0 | 36.0 | 6 | 8 | 9 | 1.1 |

NOTE: To complete the MIL-C-55365/8 Part Number, additional information must be added:

Contact your local AVX sales office for latest qualification status.

*** = Termination Finish**
 B = Gold Plated
 C = Hot Solder Dipped
 K = Solder Fused

† = Tolerance Code
 J = ±5%
 K = ±10%
 M = ±20%

@ = Failure Rate Level
 Exponential:
 M = 1.0% per 1000 hours
 P = 0.1% per 1000 hours
 R = 0.01% per 1000 hours
 S = 0.001% per 1000 hours
 Weibull:
 B = 0.1% per 1000 hours
 C = 0.01% per 1000 hours
 D = 0.001% Per 1000 hours

Δ = Optional Surge Current
 A = 10 cycles at 25°C
 B = 10 cycles at -55°C and +85°C

□ = Packaging
 Bulk Standard
 \TR=7" Tape & Reel
 \TR13=13" Tape & Reel
 \W=Waffle Pack

CWR11 Style



MIL-C-55365/8

ELECTRICAL RATINGS FOR CWR11 CAPACITORS

| MIL-C-55365/8 Part Number (See Note) | Case Size | Rated Voltage (85°C) (volts) | Capacitance (nom.) (µF) | DC Leakage (max.) | | | Dissipation Factor (max.) | | | Max. ESR 100 kHz (Ω) |
|---|--------------|---------------------------------------|-------------------------------|-------------------|---------------|----------------|---------------------------|------------------|--------------|-------------------------------|
| | | | | +25°C (µA) | +85°C (µA) | +125°C (µA) | +25°C (%) | +85/125°C (%) | -55°C (%) | |
| CWR11K*334†@△□ | A | 25 | 0.33 | 0.5 | 5.0 | 6.0 | 4 | 6 | 6 | 15.0 |
| CWR11K*474†@△□ | A | 25 | 0.47 | 0.5 | 5.0 | 6.0 | 4 | 6 | 6 | 14.0 |
| CWR11K*684†@△□ | B | 25 | 0.68 | 0.5 | 5.0 | 6.0 | 4 | 6 | 6 | 7.5 |
| CWR11K*105†@△□ | B | 25 | 1.0 | 0.5 | 5.0 | 6.0 | 4 | 6 | 6 | 6.5 |
| CWR11K*155†@△□ | B | 25 | 1.5 | 0.5 | 5.0 | 6.0 | 6 | 8 | 9 | 6.5 |
| CWR11K*225†@△□ | C | 25 | 2.2 | 0.6 | 6.0 | 7.2 | 6 | 9 | 9 | 3.5 |
| CWR11K*335†@△□ | C | 25 | 3.3 | 0.9 | 9.0 | 10.8 | 6 | 8 | 9 | 3.5 |
| CWR11K*475†@△□ | C | 25 | 4.7 | 1.2 | 12.0 | 14.4 | 6 | 9 | 9 | 2.5 |
| CWR11K*685†@△□ | D | 25 | 6.8 | 1.7 | 17.0 | 20.4 | 6 | 9 | 9 | 1.4 |
| CWR11K*106†@△□ | D | 25 | 10.0 | 2.5 | 25.0 | 30.0 | 6 | 8 | 9 | 1.2 |
| CWR11M*104†@△□ | A | 35 | 0.10 | 0.5 | 5.0 | 6.0 | 4 | 6 | 6 | 24.0 |
| CWR11M*154†@△□ | A | 35 | 0.15 | 0.5 | 5.0 | 6.0 | 4 | 6 | 6 | 21.0 |
| CWR11M*224†@△□ | A | 35 | 0.22 | 0.5 | 5.0 | 6.0 | 4 | 6 | 6 | 18.0 |
| CWR11M*334†@△□ | A | 35 | 0.33 | 0.5 | 5.0 | 6.0 | 4 | 6 | 6 | 15.0 |
| CWR11M*474†@△□ | B | 35 | 0.47 | 0.5 | 5.0 | 6.0 | 4 | 6 | 6 | 10.0 |
| CWR11M*684†@△□ | B | 35 | 0.68 | 0.5 | 5.0 | 6.0 | 4 | 6 | 6 | 8.0 |
| CWR11M*105†@△□ | B | 35 | 1.0 | 0.5 | 5.0 | 6.0 | 4 | 6 | 6 | 6.5 |
| CWR11M*155†@△□ | C | 35 | 1.5 | 0.5 | 5.0 | 6.0 | 6 | 8 | 9 | 4.5 |
| CWR11M*225†@△□ | C | 35 | 2.2 | 0.8 | 8.0 | 9.6 | 6 | 8 | 9 | 3.5 |
| CWR11M*335†@△□ | C | 35 | 3.3 | 1.2 | 12.0 | 14.4 | 6 | 8 | 9 | 2.5 |
| CWR11M*475†@△□ | D | 35 | 4.7 | 1.7 | 17.0 | 20.4 | 6 | 8 | 9 | 1.5 |
| CWR11N*104†@△□ | A | 50 | 0.10 | 0.5 | 5.0 | 6.0 | 4 | 6 | 6 | 22.0 |
| CWR11N*154†@△□ | B | 50 | 0.15 | 0.5 | 5.0 | 6.0 | 4 | 6 | 6 | 17.0 |
| CWR11N*224†@△□ | B | 50 | 0.22 | 0.5 | 5.0 | 6.0 | 4 | 6 | 6 | 14.0 |
| CWR11N*334†@△□ | B | 50 | 0.33 | 0.5 | 5.0 | 6.0 | 4 | 6 | 6 | 12.0 |
| CWR11N*474†@△□ | C | 50 | 0.47 | 0.5 | 5.0 | 6.0 | 4 | 6 | 6 | 8.0 |
| CWR11N*684†@△□ | C | 50 | 0.68 | 0.5 | 5.0 | 6.0 | 6 | 6 | 6 | 7.0 |
| CWR11N*105†@△□ | C | 50 | 1.0 | 0.5 | 5.0 | 6.0 | 6 | 6 | 6 | 6.0 |
| CWR11N*155†@△□ | D | 50 | 1.5 | 0.8 | 8.0 | 9.6 | 6 | 8 | 9 | 4.0 |
| CWR11N*225†@△□ | D | 50 | 2.2 | 1.1 | 11.0 | 13.2 | 6 | 8 | 9 | 2.5 |

NOTE: To complete the MIL-C-55365/8 Part Number, additional information must be added:

Contact your local AVX sales office for latest qualification status.

*** = Termination Finish**
 Designator:
 B = Gold Plated
 C = Hot Solder Dipped
 K = Solder Fused

† = Tolerance Code
 J = ±5%
 K = ±10%
 M = ±20%

@ = Failure Rate Level
 Exponential:
 M = 1.0% per 1000 hours
 P = 0.1% per 1000 hours
 R = 0.01% per 1000 hours
 S = 0.001% per 1000 hours
 Weibull:
 B = 0.1% per 1000 hours
 C = 0.01% per 1000 hours
 D = 0.001% per 1000 hours

△ = Optional Surge Current
 A = 10 cycles at 25°C
 B = 10 cycles at -55°C
 and +85°C

□ = Packaging
 Bulk Standard
 \TR=7" Tape & Reel
 \TR13=13" Tape & Reel
 \W=Waffle Pack



Technical Summary and Application Guidelines



INTRODUCTION

Tantalum capacitors are manufactured from a powder of pure tantalum metal. The typical particle size is between 2 and 10 μm .

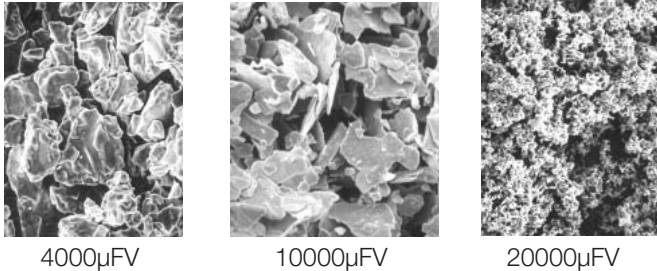

Figure 1.

The powder is compressed under high pressure around a Tantalum wire to form a 'pellet' (known as the Riser Wire). The riser wire is the anode connection to the capacitor.

This is subsequently vacuum sintered at high temperature (typically 1500 - 2000°C). This helps to drive off any impurities within the powder by migration to the surface.

During sintering the powder becomes a sponge like structure with all the particles interconnected in a huge lattice.

This structure is of high mechanical strength and density, but is also highly porous giving a large internal surface area (see Figure 2).

The larger the surface area the larger the capacitance. Thus high CV (capacitance/voltage product) powders, which have a low average particle size, are used for low voltage, high capacitance parts. The figure below shows typical powders. Note the very great difference in particle size between the powder CVs.

By choosing which powder is used to produce each capacitance/voltage rating the surface area can be controlled.

The following example uses a 22 μF 25V capacitor to illustrate the point.

$$C = \frac{\epsilon_0 \epsilon_r A}{d}$$

where ϵ_0 is the dielectric constant of free space (8.855 x 10⁻¹² Farads/m)
 ϵ_r is the relative dielectric constant for Tantalum Pentoxide (27)
 d is the dielectric thickness in meters (for a typical 25V part)
 C is the capacitance in Farads
 and A is the surface area in meters

Rearranging this equation gives:

$$A = \frac{Cd}{\epsilon_0 \epsilon_r}$$

thus for a 22 μF /25V capacitor the surface area is 150 square centimeters, or nearly half the size of this page.

The dielectric is then formed over all the tantalum surfaces by the electrochemical process of anodization. To achieve this, the 'pellet' is dipped into a very weak solution of phosphoric acid.

The dielectric thickness is controlled by the voltage applied during the forming process. Initially the power supply is kept in a constant current mode until the correct thickness of dielectric has been reached (that is the voltage reaches the 'forming voltage'), it then switches to constant voltage mode and the current decays to close to zero.

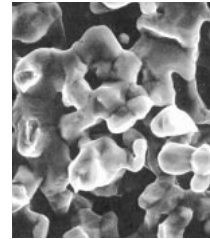
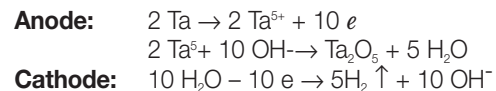

Figure 2. Sintered Tantalum

The chemical equations describing the process are as follows:



The oxide forms on the surface of the Tantalum but it also grows into the metal. For each unit of oxide two thirds grows out and one third grows in. It is for this reason that there is a limit on the maximum voltage rating of Tantalum capacitors with present technology powders (see Figure 3).

The dielectric operates under high electrical stress. Consider a 22 μF 25V part:

Formation voltage = Formation Ratio x Working Voltage
 = 4 x 25
 = 100 Volts

Technical Summary and Application Guidelines



The pentoxide (Ta_2O_5) dielectric grows at a rate of 1.7×10^{-9} m/V

Dielectric thickness (d) = $100 \times 1.7 \times 10^{-9}$
= $0.17 \mu\text{m}$

Electric Field strength = Working Voltage / d
= 147 KV/mm

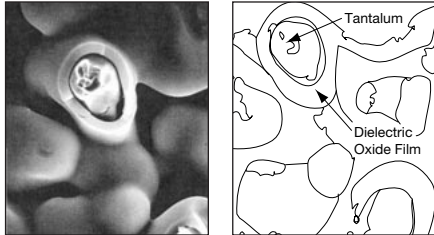

Figure 3. Dielectric Layer

The next stage is the production of the cathode plate. This is achieved by pyrolysis of Manganese Nitrate into Manganese Dioxide.

The 'pellet' is dipped into an aqueous solution of nitrate and then baked in an oven at approximately 250°C to produce the dioxide coat. The chemical equation is:

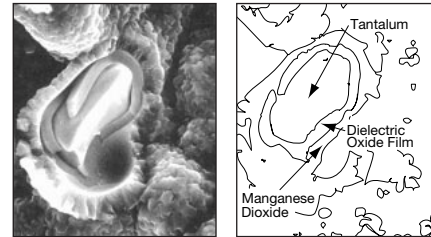
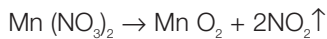
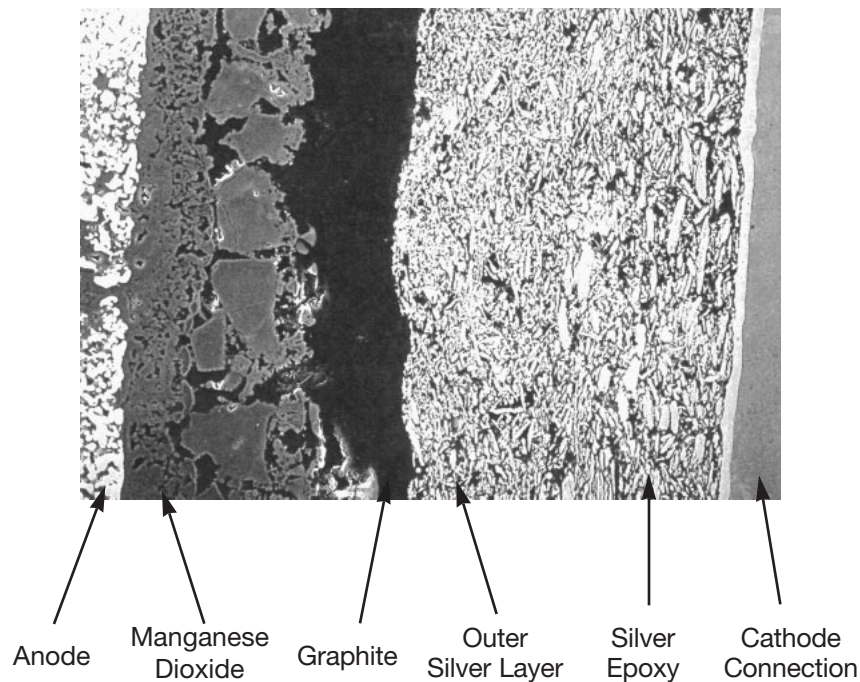

Figure 4. Manganese Dioxide Layer

This process is repeated several times through varying specific densities of nitrate to build up a thick coat over all internal and external surfaces of the 'pellet', as shown in Figure 4.

The 'pellet' is then dipped into graphite and silver to provide a good connection to the Manganese Dioxide cathode plate. Electrical contact is established by deposition of carbon onto the surface of the cathode. The carbon is then coated with a conductive material to facilitate connection to the cathode termination. Packaging is carried out to meet individual specifications and customer requirements. This manufacturing technique is adhered to for the whole range of AVX tantalum capacitors, which can be subdivided into four basic groups: Chip / Resin dipped / Rectangular boxed / Axial.

Further information on the production of Tantalum Capacitors can be obtained from the technical paper "Basic Tantalum Technology", by John Gill, available from your local AVX representative.



SECTION 1 ELECTRICAL CHARACTERISTICS AND EXPLANATION OF TERMS

1.1 CAPACITANCE

1.1.1 Rated capacitance (C_R).

This is the nominal rated capacitance. For tantalum capacitors it is measured as the capacitance of the equivalent series circuit at 20°C using a measuring bridge supplied by a 0.5Vpk-pk 120Hz sinusoidal signal, free of harmonics with a maximum bias of 2.2Vd.c.

1.1.2 Capacitance tolerance.

This is the permissible variation of the actual value of the capacitance from the rated value. For additional reading, please consult the AVX technical publication "Capacitance Tolerances for Solid Tantalum Capacitors".

1.1.3 Temperature dependence of capacitance.

The capacitance of a tantalum capacitor varies with temperature. This variation itself is dependent to a small extent on the rated voltage and capacitor size.

1.1.4 Frequency dependence of the capacitance.

The effective capacitance decreases as frequency increases. Beyond 100KHz the capacitance continues to drop until resonance is reached (typically between 0.5 - 5MHz depending on the rating). Beyond the resonant frequency the device becomes inductive.

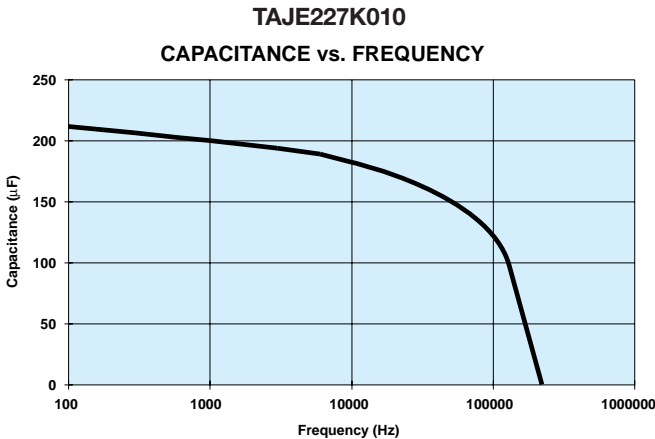

1.2 VOLTAGE

1.2.1 Rated d.c. voltage (V_R)

This is the rated d.c. voltage for continuous operation at 85°C.

1.2.2 Category voltage (V_C)

This is the maximum voltage that may be applied continuously to a capacitor. It is equal to the rated voltage up to +85°C, beyond which it is subject to a linear derating, to 2/3 V_R at 125°C.

1.2.3 Surge voltage (V_S)

This is the highest voltage that may be applied to a capacitor for short periods of time. The surge voltage may be applied up to 10 times in an hour for periods of up to 30 seconds at a time. The surge voltage must not be used as a parameter in the design of circuits in which, in the normal course of operation, the capacitor is periodically charged and discharged.

| 85°C | | 125°C | |
|----------------------|----------------------|-------------------------|----------------------|
| Rated Voltage (Vdc.) | Surge Voltage (Vdc.) | Category Voltage (Vdc.) | Surge Voltage (Vdc.) |
| 4 | 5.2 | 2.7 | 3.2 |
| 6.3 | 8 | 4 | 5 |
| 10 | 13 | 7.0 | 8 |
| 16 | 20 | 10 | 12 |
| 20 | 26 | 13 | 16 |
| 25 | 32 | 17 | 20 |
| 35 | 46 | 23 | 28 |
| 50 | 65 | 33 | 40 |

1.2.4 Effect of surges

The solid Tantalum capacitor has a limited ability to withstand voltage and current surges. This is in common with all other electrolytic capacitors and is due to the fact that they operate under very high electrical stress across the dielectric. For example a 25 volt capacitor has an Electrical Field of 147 KV/mm when operated at rated voltage.

It is important to ensure that the voltage across the terminals of the capacitor never exceeds the specified surge voltage rating.

Solid tantalum capacitors have a self healing ability provided by the Manganese Dioxide semiconducting layer used as the negative plate. However, this is limited in low impedance applications.

In the case of low impedance circuits, the capacitor is likely to be stressed by current surges. Derating the capacitor by 50% or more increases the reliability of the component. (See Figure 2 page 37). The "AVX Recommended Derating Table" (page 38) summarizes voltage rating for use on common voltage rails, in low impedance applications.

In circuits which undergo rapid charge or discharge a protective resistor of $1\Omega/V$ is recommended. If this is impossible, a derating factor of up to 70% should be used.

In such situations a higher voltage may be needed than is available as a single capacitor. A series combination should be used to increase the working voltage of the equivalent capacitor: For example two $22\mu F$ 25V parts in series is equivalent to one $11\mu F$ 50V part. For further details refer to J.A. Gill's paper "Investigation into the effects of connecting Tantalum capacitors in series", available from AVX offices worldwide.

NOTE:

While testing a circuit (e.g. at ICT or functional) it is likely that the capacitors will be subjected to large voltage and current transients, which will not be seen in normal use. These conditions should be borne in mind when considering the capacitor's rated voltage for use. These can be controlled by ensuring a correct test resistance is used.

1.2.5 Reverse voltage and Non-Polar operation.

The values quoted are the maximum levels of reverse voltage which should appear on the capacitors at any time. These limits are based on the assumption that the capacitors are polarized in the correct direction for the majority of their working life. They are intended to cover short term reversals of polarity such as those occurring during switching transients or during a minor portion of an impressed waveform. Continuous application of reverse voltage without normal polarization will result in a degradation of leakage current. In conditions under which continuous application of a reverse voltage could occur two similar capacitors should be used in a back-to-back configuration with the negative terminations connected together. Under most conditions this combination will have a capacitance one half of the nominal capacitance of either capacitor. Under conditions of isolated pulses or during the first few cycles, the capacitance may approach the full nominal value.

The reverse voltage ratings are designed to cover exceptional conditions of small level excursions into incorrect polarity. The values quoted are not intended to cover continuous reverse operation.

The peak reverse voltage applied to the capacitor must not exceed:

10% of the rated d.c. working voltage to a maximum of 1.0v at 25°C

3% of the rated d.c. working voltage to a maximum of 0.5v at 85°C

1% of the category d.c. working voltage to a maximum of 0.1v at 125°C

1.2.6 Superimposed A.C. Voltage (Vr.m.s.) - Ripple Voltage.

This is the maximum r.m.s. alternating voltage; superimposed on a d.c. voltage, that may be applied to a capacitor. The sum of the d.c. voltage and peak value of the super-imposed a.c. voltage must not exceed the category voltage, V_c .

Full details are given in Section 2.

1.2.7 Forming voltage.

This is the voltage at which the anode oxide is formed. The thickness of this oxide layer is proportional to the formation voltage for a tantalum capacitor and is a factor in setting the rated voltage.

1.3 DISSIPATION FACTOR AND TANGENT OF LOSS ANGLE ($\tan \delta$)

1.3.1 Dissipation factor (D.F.).

Dissipation factor is the measurement of the tangent of the loss angle ($\tan \delta$) expressed as a percentage. The measurement of DF is carried out using a measuring bridge which supplies a 0.5Vpk-pk 120Hz sinusoidal signal, free of harmonics with a maximum bias of 2.2Vdc. The value of DF is temperature and frequency dependent.

Note: For surface mounted products the maximum allowed DF values are indicated in the ratings table and it is important to note that these are the limits met by the component AFTER soldering onto the substrate.

1.3.2 Tangent of Loss Angle ($\tan \delta$).

This is a measurement of the energy loss in the capacitor. It is expressed as $\tan \delta$ and is the power loss of the capacitor divided by its reactive power at a sinusoidal voltage of specified frequency. Terms also used are power factor, loss factor and dielectric loss. $\cos(90 - \delta)$ is the true power factor. The measurement of $\tan \delta$ is carried out using a measuring bridge which supplies a 0.5Vpk-pk 120Hz sinusoidal signal, free of harmonics with a maximum bias of 2.2Vdc.

1.3.3 Frequency dependence of Dissipation Factor.

Dissipation Factor increases with frequency as shown in the typical curves:

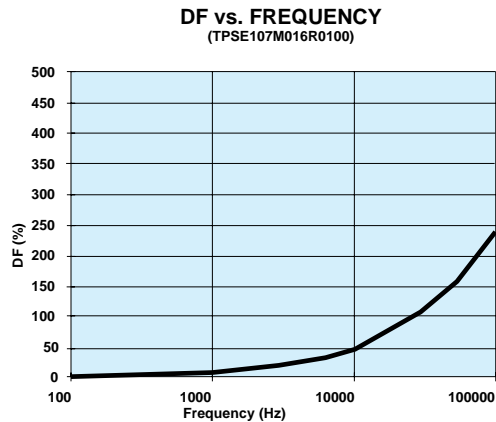

1.3.4 Temperature dependence of Dissipation Factor.

Dissipation factor varies with temperature as the typical curves show. For maximum limits please refer to ratings tables.

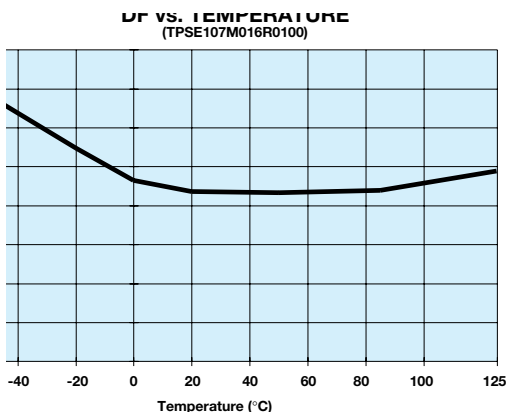

1.4.2 Equivalent Series Resistance, ESR.

Resistance losses occur in all practical forms of capacitors. These are made up from several different mechanisms, including resistance in components and contacts, viscous forces within the dielectric and defects producing bypass current paths. To express the effect of these losses they are considered as the ESR of the capacitor. The ESR is frequency dependent and can be found by using the relationship;

$$ESR = \frac{\tan \delta}{2\pi fC}$$

Where f is the frequency in Hz, and C is the capacitance in farads.

The ESR is measured at 20°C and 100kHz.

ESR is one of the contributing factors to impedance, and at high frequencies (100kHz and above) it becomes the dominant factor. Thus ESR and impedance become almost identical, impedance being only marginally higher.

1.4.3 Frequency dependence of Impedance and ESR.

ESR and Impedance both increase with decreasing frequency. At lower frequencies the values diverge as the extra contributions to impedance (due to the reactance of the capacitor) become more significant. Beyond 1MHz (and beyond the resonant point of the capacitor) impedance again increases due to the inductance of the capacitor.

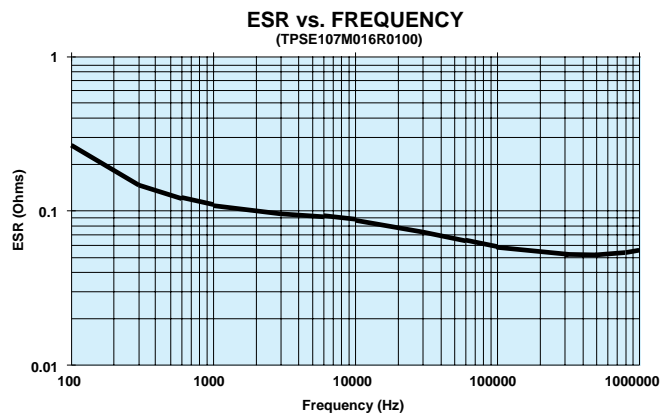

1.4 IMPEDANCE, (Z) AND EQUIVALENT SERIES RESISTANCE (ESR)

1.4.1 Impedance, Z.

This is the ratio of voltage to current at a specified frequency. Three factors contribute to the impedance of a tantalum capacitor; the resistance of the semiconductor layer; the capacitance value and the inductance of the electrodes and leads.

At high frequencies the inductance of the leads becomes a limiting factor. The temperature and frequency behavior of these three factors of impedance determine the behavior of the impedance Z . The impedance is measured at 20°C and 100kHz.

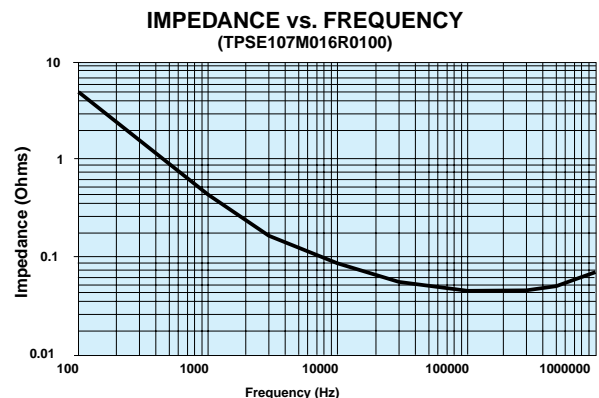

Technical Summary and Application Guidelines



1.4.4 Temperature dependence of the Impedance and ESR.

At 100kHz, impedance and ESR behave identically and decrease with increasing temperature as the typical curves show.

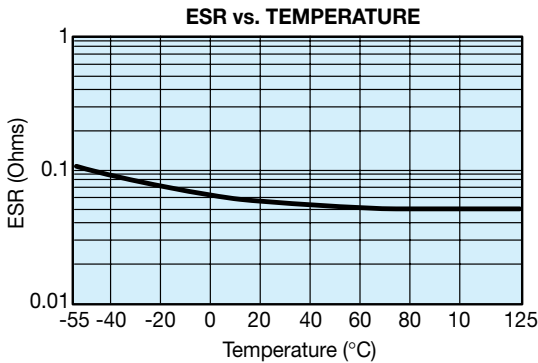

1.5 D.C. LEAKAGE CURRENT

1.5.1 Leakage current.

The leakage current is dependent on the voltage applied, the elapsed time since the voltage was applied and the component temperature. It is measured at +20°C with the rated voltage applied. A protective resistance of 1000Ω is connected in series with the capacitor in the measuring circuit. Three to five minutes after application of the rated voltage the leakage current must not exceed the maximum values indicated in the ratings table. These are based on the formulae 0.01CV or 0.5μA (whichever is the greater).

Reforming of tantalum capacitors is unnecessary even after prolonged storage periods without the application of voltage.

1.5.2 Temperature dependence of the leakage current.

The leakage current increases with higher temperatures, typical values are shown in the graph. For operation between 85°C and 125°C, the maximum working voltage must be derated and can be found from the following formula.

$$V_{max} = \left(1 - \frac{T - 85}{125}\right) \times V_R \text{ volts, where } T \text{ is the required}$$

operating temperature.

LEAKAGE CURRENT vs. TEMPERATURE

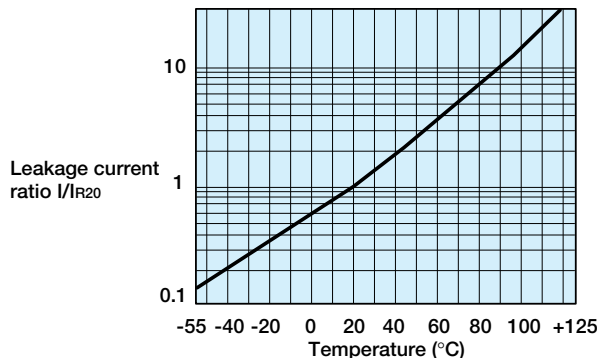

1.5.3 Voltage dependence of the leakage current.

The leakage current drops rapidly below the value corresponding to the rated voltage V_R when reduced voltages are applied. The effect of voltage derating on the leakage current is shown in the graph. This will also give a significant increase in the reliability for any application. See Section 3.1 for details.

LEAKAGE CURRENT vs. RATED VOLTAGE

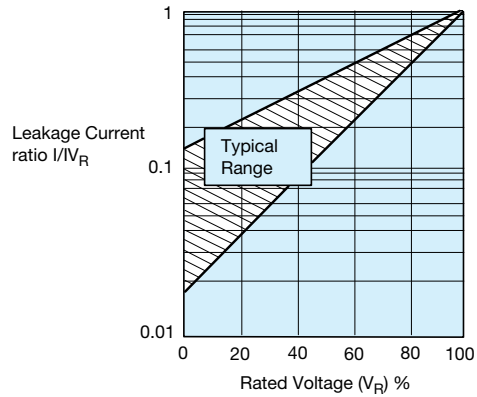

For additional information on Leakage Current, please consult the AVX technical publication "Analysis of Solid Tantalum Capacitor Leakage Current" by R. W. Franklin.

1.5.4 Ripple current.

The maximum ripple current allowed can be calculated from the power dissipation limits for a given temperature rise above ambient temperature (please refer to Section 2).

LEAKAGE CURRENT vs. BIAS VOLTAGE

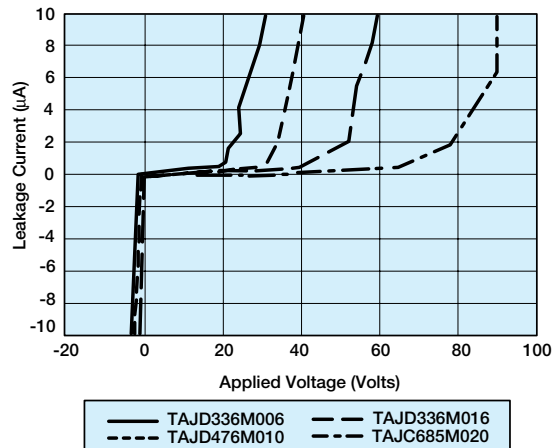

SECTION 2

A.C. OPERATION, RIPPLE VOLTAGE AND RIPPLE CURRENT

2.1 RIPPLE RATINGS (A.C.)

In an a.c. application heat is generated within the capacitor by both the a.c. component of the signal (which will depend upon the signal form, amplitude and frequency), and by the d.c. leakage. For practical purposes the second factor is insignificant. The actual power dissipated in the capacitor is calculated using the formula:

$$P = I^2 R$$

and rearranged to $I = \sqrt{\frac{P}{R}}$ (Eq. 1)

and substituting $P = \frac{E^2 R}{Z^2}$

- where
- I = rms ripple current, amperes
 - R = equivalent series resistance, ohms
 - E = rms ripple voltage, volts
 - P = power dissipated, watts
 - Z = impedance, ohms, at frequency under consideration

Maximum a.c. ripple voltage (E_{max}).

From the previous equation:

$$E_{max} = Z \sqrt{\frac{P}{R}}$$
(Eq. 2)

Where P is the maximum permissible power dissipated as listed for the product under consideration (see tables). However care must be taken to ensure that:

1. The d.c. working voltage of the capacitor must not be exceeded by the sum of the positive peak of the applied a.c. voltage and the d.c. bias voltage.
2. The sum of the applied d.c. bias voltage and the negative peak of the a.c. voltage must not allow a voltage reversal in excess of the "Reverse Voltage".

Historical ripple calculations.

Previous ripple current and voltage values were calculated using an empirically derived power dissipation required to give a 10°C rise of the capacitors body temperature from room temperature, usually in free air. These values are shown in Table I. Equation 1 then allows the maximum ripple current to be established, and Equation 2, the maximum ripple voltage. But as has been shown in the AVX article on thermal management by I. Salisbury, the thermal conductivity of a Tantalum chip capacitor varies considerably depending upon how it is mounted.

Table I: Power Dissipation Ratings (In Free Air)

TAJ/TPS/CWR11 Series Molded Chip

| Case size | Max. power dissipation (W) |
|-----------|----------------------------|
| A | 0.075 |
| B | 0.085 |
| C | 0.110 |
| D | 0.150 |
| E | 0.165 |
| M | 0.090 |
| N | 0.130 |
| R | 0.055 |
| S | 0.065 |
| T | 0.080 |
| V | 0.250 |

TAZ/CWR09 Series Molded Chip

| Case size | Max. power dissipation (W) |
|-----------|----------------------------|
| A | 0.050 |
| B | 0.070 |
| C | 0.075 |
| D | 0.080 |
| E | 0.090 |
| F | 0.100 |
| G | 0.125 |
| H | 0.150 |

**TAJ/TPS/CWR11
TAZ/CWR09 Series Molded Chip**

| Temperature derating factors | |
|------------------------------|--------|
| Temp. °C | Factor |
| +25 | 1.0 |
| +55 | 0.90 |
| +85 | 0.80 |
| +125 | 0.16 |

| Temperature correction factor for ripple current | |
|--|--------|
| Temp. °C | Factor |
| +25 | 1.0 |
| +55 | 0.95 |
| +85 | 0.90 |
| +125 | 0.40 |

Technical Summary and Application Guidelines



A piece of equipment was designed which would pass sine and square wave currents of varying amplitudes through a biased capacitor. The temperature rise seen on the body for the capacitor was then measured using an infra-red probe. This ensured that there was no heat loss through any thermocouple attached to the capacitor's surface.

Results for the C, D and E case sizes

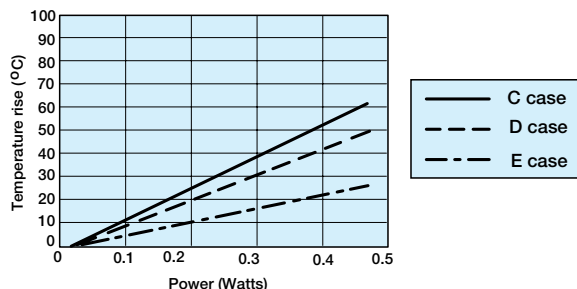

Several capacitors were tested and the combined results are shown here. All these capacitors were measured on FR4 board, with no other heatsinking. The ripple was supplied at various frequencies from 1KHz to 1MHz.

As can be seen in the figure above, the average P_{max} value for the C case capacitors was 0.11 Watts. This is the same as that quoted in Table I.

The D case capacitors gave an average P_{max} value 0.125 Watts. This is lower than the value quoted in the Table I by 0.025 Watts.

The E case capacitors gave an average P_{max} of 0.200 Watts which was much higher than the 0.165 Watts from Table I.

If a typical capacitor's ESR with frequency is considered, e.g. figure below, it can be seen that there is variation. Thus for a set ripple current, the amount of power to be dissipated by the capacitor will vary with frequency. This is clearly shown in figure in top of next column, which shows that the surface temperature of the unit rises less for a given value of ripple current at 1MHz than at 100KHz.

The graph below shows a typical ESR variation with frequency. Typical ripple current versus temperature rise for 100KHz and 1MHz sine wave inputs.

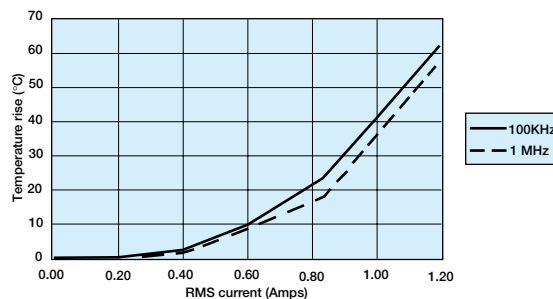
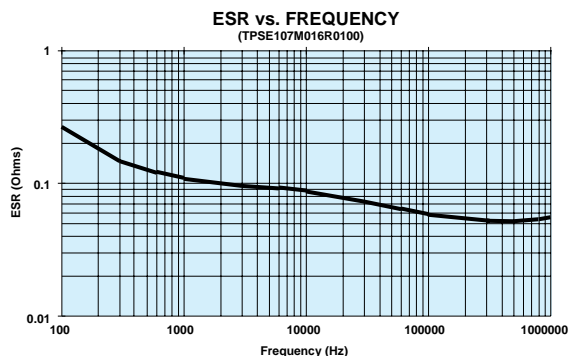

If I^2R is then plotted it can be seen that the two lines are in fact coincident, as shown in figure below.

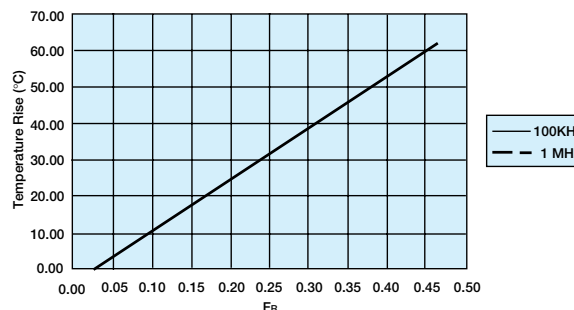

Example

A Tantalum capacitor is being used in a filtering application, where it will be required to handle a 2 Amp peak-to-peak, 200KHz square wave current.

A square wave is the sum of an infinite series of sine waves at all the odd harmonics of the square waves fundamental frequency. The equation which relates is:

$$I_{square} = I_{pk} \sin(2\pi f) + I_{pk} \sin(6\pi f) + I_{pk} \sin(10\pi f) + I_{pk} \sin(14\pi f) + \dots$$

Thus the special components are:

| Frequency | Peak-to-peak current (Amps) | RMS current (Amps) |
|-----------|-----------------------------|--------------------|
| 200 KHz | 2.000 | 0.707 |
| 600 KHz | 0.667 | 0.236 |
| 1 MHz | 0.400 | 0.141 |
| 1.4 MHz | 0.286 | 0.101 |

Let us assume the capacitor is a TAJD686M006

Typical ESR measurements would yield.

| Frequency | Typical ESR (Ohms) | Power (Watts) $I_{rms}^2 \times ESR$ |
|-----------|--------------------|--------------------------------------|
| 200 KHz | 0.120 | 0.060 |
| 600 KHz | 0.115 | 0.006 |
| 1 MHz | 0.090 | 0.002 |
| 1.4 MHz | 0.100 | 0.001 |

Thus the total power dissipation would be 0.069 Watts.

From the D case results shown in figure top of previous column, it can be seen that this power would cause the capacitors surface temperature to rise by about 5°C. For additional information, please refer to the AVX technical publication "Ripple Rating of Tantalum Chip Capacitors" by R.W. Franklin.

Technical Summary and Application Guidelines



2.2 Thermal Management

The heat generated inside a tantalum capacitor in a.c. operation comes from the power dissipation due to ripple current. It is equal to I^2R , where I is the rms value of the current at a given frequency, and R is the ESR at the same frequency with an additional contribution due to the leakage current. The heat will be transferred from the outer surface by conduction. How efficiently it is transferred from this point is dependent on the thermal management of the board.

The power dissipation ratings given in Section 2.1 are based on free-air calculations. These ratings can be approached if efficient heat sinking and/or forced cooling is used.

In practice, in a high density assembly with no specific thermal management, the power dissipation required to give a 10°C rise above ambient may be up to a factor of 10 less. In these cases, the actual capacitor temperature should be established (either by thermocouple probe or infra-red scanner) and if it is seen to be above this limit it may be necessary to specify a lower ESR part or a higher voltage rating.

Please contact application engineering for details or contact the AVX technical publication entitled "Thermal Management of Surface Mounted Tantalum Capacitors" by Ian Salisbury.

Thermal Dissipation from the Mounted Chip

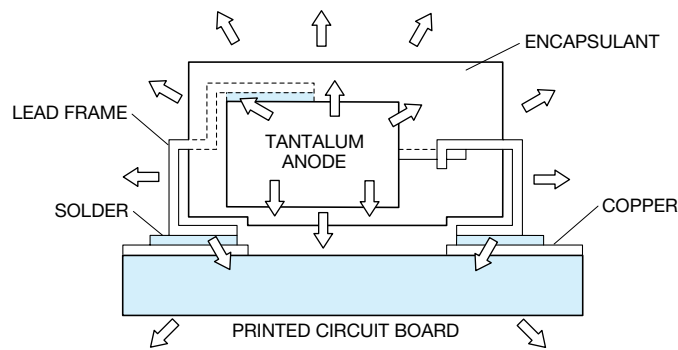

Thermal Impedance Graph with Ripple Current

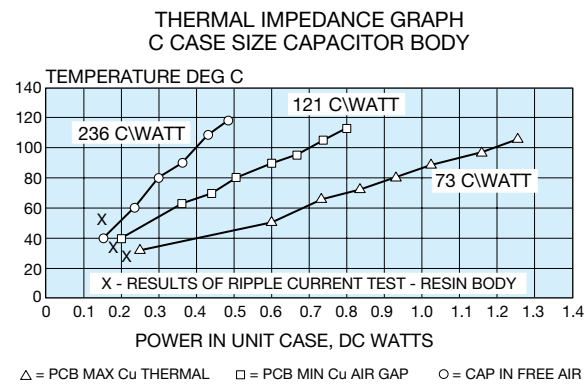

SECTION 3 RELIABILITY AND CALCULATION OF FAILURE RATE

3.1 STEADY-STATE

Tantalum Dielectric has essentially no wear out mechanism and in certain circumstances is capable of limited self healing. However, random failures can occur in operation. The failure rate of Tantalum capacitors will decrease with time and not increase as with other electrolytic capacitors and other electronic components.

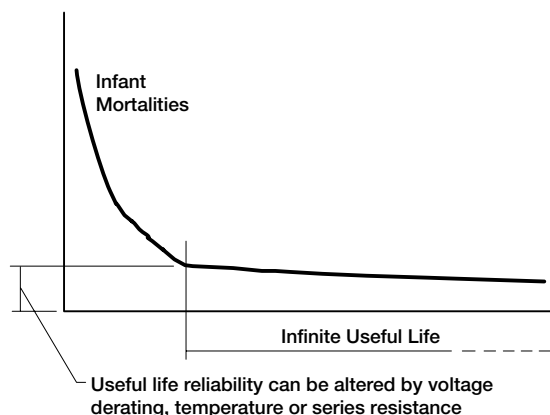

Figure 1. Tantalum Reliability Curve

The useful life reliability of the Tantalum capacitor is affected by three factors. The equation from which the failure rate can be calculated is:

$$F = FU \times FT \times FR \times FB$$

where

- FU is a correction factor due to operating voltage/voltage derating
- FT is a correction factor due to operating temperature
- FR is a correction factor due to circuit series resistance
- FB is the basic failure rate level. For standard Tantalum product this is 1%/1000 hours

Base failure rate.

Standard tantalum product conforms to Level M reliability (i.e., 1%/1000 hrs.) at rated voltage, rated temperature, and 0.1Ω/volt circuit impedance. This is known as the base failure rate, FB, which is used for calculating operating reliability. The effect of varying the operating conditions on failure rate is shown on this page.

Operating voltage/voltage derating.

If a capacitor with a higher voltage rating than the maximum line voltage is used, then the operating reliability will be improved. This is known as voltage derating.

The graph, Figure 2, shows the relationship between voltage derating (the ratio between applied and rated voltage) and the failure rate. The graph gives the correction factor FU for any operating voltage.

Figure 2. Correction factor to failure rate F for voltage derating of a typical component (60% con. level).

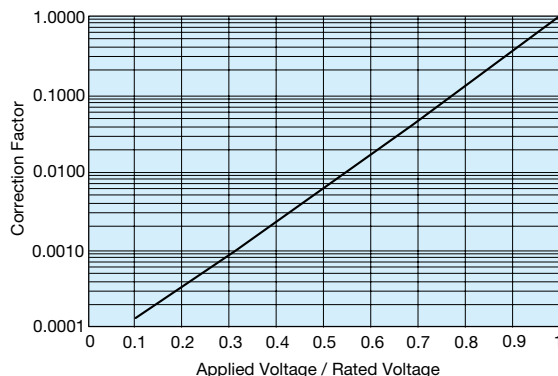

Operating Temperature.

If the operating temperature is below the rated temperature for the capacitor then the operating reliability will be improved as shown in Figure 3. This graph gives a correction factor FT for any temperature of operation.

Figure 3: Correction factor to failure rate F for ambient temperature T for typical component (60% con. level).

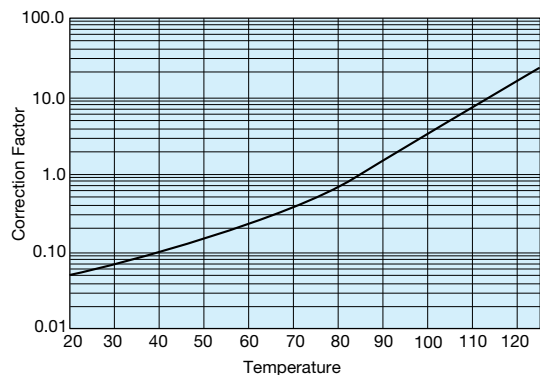

Circuit Impedance.

All solid tantalum capacitors require current limiting resistance to protect the dielectric from surges. A series resistor is recommended for this purpose. A lower circuit impedance may cause an increase in failure rate, especially at temperatures higher than 20°C. An inductive low impedance circuit may apply voltage surges to the capacitor and similarly a non-inductive circuit may apply current surges to the capacitor, causing localized over-heating and failure. The recommended impedance is 1 Ω per volt. Where this is not feasible, equivalent voltage derating should be used (See MIL HANDBOOK 217E). The graph, Figure 4, shows the correction factor, FR, for increasing series resistance.

Technical Summary and Application Guidelines



Figure 4. Correction factor to failure rate F for series resistance R on basic failure rate FB for a typical component (60% con. level).

| Circuit resistance ohms/volt | FR |
|------------------------------|------|
| 3.0 | 0.07 |
| 2.0 | 0.1 |
| 1.0 | 0.2 |
| 0.8 | 0.3 |
| 0.6 | 0.4 |
| 0.4 | 0.6 |
| 0.2 | 0.8 |
| 0.1 | 1.0 |

Example calculation

Consider a 12 volt power line. The designer needs about 10 μ F of capacitance to act as a decoupling capacitor near a video bandwidth amplifier. Thus the circuit impedance will be limited only by the output impedance of the board's power unit and the track resistance. Let us assume it to be about 2 Ohms minimum, i.e. 0.167 Ohms/Volt. The operating temperature range is -25°C to +85°C. If a 10 μ F 16 Volt capacitor was designed in the operating failure rate would be as follows.

- a) FT = 1.0 @ 85°C
- b) FR = 0.85 @ 0.167 Ohms/Volt
- c) FU = 0.08 @ applied voltage/rated voltage = 75%

Thus $FB = 1.0 \times 0.85 \times 0.08 \times 1 = 0.068\%/1000$ Hours

If the capacitor was changed for a 20 volt capacitor, the operating failure rate will change as shown.

- FU = 0.018 @ applied voltage/rated voltage = 60%
- $FB = 1.0 \times 0.85 \times 0.018 \times 1 = 0.0153\%/1000$ Hours

3.2 Dynamic.

As stated in Section 1.2.4, the solid Tantalum capacitor has a limited ability to withstand voltage and current surges. Such current surges can cause a capacitor to fail. The expected failure rate cannot be calculated by a simple formula as in the case of steady-state reliability. The two parameters under the control of the circuit design engineer known to reduce the incidence of failures are derating and series resistance.

The table below summarizes the results of trials carried out at AVX with a piece of equipment which has very low series resistance with no voltage derating applied. That is the capacitor was tested at its rated voltage.

Results of production scale derating experiment

| Capacitance and Voltage | Number of units tested | 50% derating applied | No derating applied |
|-------------------------|------------------------|----------------------|---------------------|
| 47 μ F 16V | 1,547,587 | 0.03% | 1.1% |
| 100 μ F 10V | 632,876 | 0.01% | 0.5% |
| 22 μ F 25V | 2,256,258 | 0.05% | 0.3% |

As can clearly be seen from the results of this experiment, the more derating applied by the user, the less likely the probability of a surge failure occurring.

It must be remembered that these results were derived from a highly accelerated surge test machine, and failure rates in the low ppm are more likely with the end customer.

A commonly held misconception is that the leakage current of a Tantalum capacitor can predict the number of failures which will be seen on a surge screen. This can be disproved by the results of an experiment carried out at AVX on 47 μ F 10V surface mount capacitors with different leakage currents. The results are summarized in the table below.

Leakage current vs number of surge failures

| | Number tested | Number failed surge |
|---|---------------|---------------------|
| Standard leakage range 0.1 μ A to 1 μ A | 10,000 | 25 |
| Over Catalog limit 5 μ A to 50 μ A | 10,000 | 26 |
| Classified Short Circuit 50 μ A to 500 μ A | 10,000 | 25 |

Again, it must be remembered that these results were derived from a highly accelerated surge test machine, and failure rates in the low ppm are more likely with the end customer.

AVX recommended derating table

| Voltage Rail | Working Cap Voltage |
|--------------|--------------------------|
| 3.3 | 6.3 |
| 5 | 10 |
| 10 | 20 |
| 12 | 25 |
| 15 | 35 |
| ≥ 24 | Series Combinations (11) |

For further details on surge in Tantalum capacitors refer to J.A. Gill's paper "Surge in solid Tantalum capacitors", available from AVX offices worldwide.

An added bonus of increasing the derating applied in a circuit, to improve the ability of the capacitor to withstand surge conditions, is that the steady-state reliability is improved by up to an order. Consider the example of a 6.3 volt capacitor being used on a 5 volt rail.

The steady-state reliability of a Tantalum capacitor is affected by three parameters; temperature, series resistance and voltage derating. Assume 40°C operation and 0.1 Ohms/Volt series resistance.

Technical Summary and Application Guidelines



The capacitors reliability will therefore be:

$$\begin{aligned} \text{Failure rate} &= F_U \times F_T \times F_R \times 1\%/1000 \text{ hours} \\ &= 0.15 \times 0.1 \times 1 \times 1\%/1000 \text{ hours} \\ &= 0.015\%/1000 \text{ hours} \end{aligned}$$

If a 10 volt capacitor was used instead, the new scaling factor would be 0.006, thus the steady-state reliability would be:

$$\begin{aligned} \text{Failure rate} &= F_U \times F_T \times F_R \times 1\%/1000 \text{ hours} \\ &= 0.006 \times 0.1 \times 1 \times 1\%/1000 \text{ hours} \\ &= 6 \times 10^{-4} \%/1000 \text{ hours} \end{aligned}$$

SECTION 4 APPLICATION GUIDELINES FOR TANTALUM CAPACITORS

So there is an order improvement in the capacitors steady-state reliability.

Soldering Conditions and Board Attachment.

The soldering temperature and time should be the minimum for a good connection.

A suitable combination for wavesoldering is 230 - 250°C for 3 - 5 seconds.

For vapor phase or infra-red reflow soldering the profile below shows allowable and dangerous time/temperature combinations. The profile refers to the peak reflow tempera-

ture and is designed to ensure that the temperature of the internal construction of the capacitor does not exceed 220°C. Preheat conditions vary according to the reflow system used, maximum time and temperature would be 10 minutes at 150°C. Small parametric shifts may be noted immediately after reflow, components should be allowed to stabilize at room temperature prior to electrical testing.

Both TAJ and TAZ series are designed for reflow and wave soldering operations. In addition TAZ is available with gold terminations compatible with conductive epoxy or gold wire bonding for hybrid assemblies.

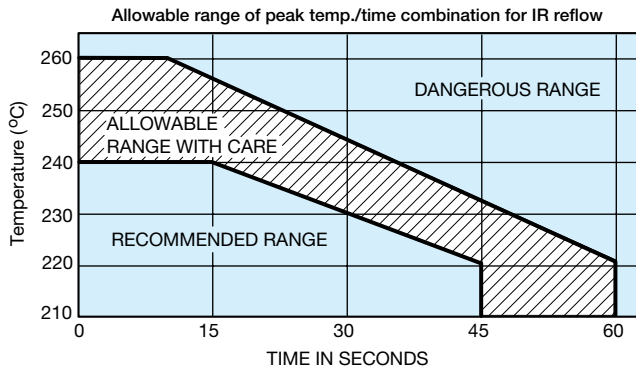
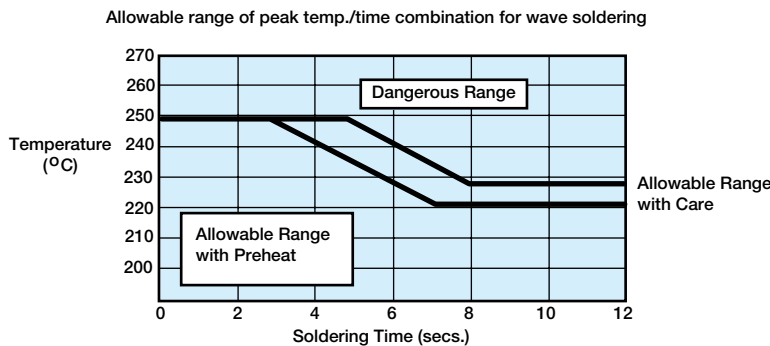

Under the CECC 00 802 International Specification, AVX Tantalum capacitors are a Class A component.

The capacitors can therefore be subjected to one IR reflow, one wave solder and one soldering iron cycle.

If more aggressive mounting techniques are to be used please consult AVX Tantalum for guidance.

Technical Summary and Application Guidelines



SECTION 4 APPLICATION GUIDELINES FOR TANTALUM CAPACITORS

Recommended soldering profiles for surface mounting of tantalum capacitors is provided in figure below.

IR REFLOW

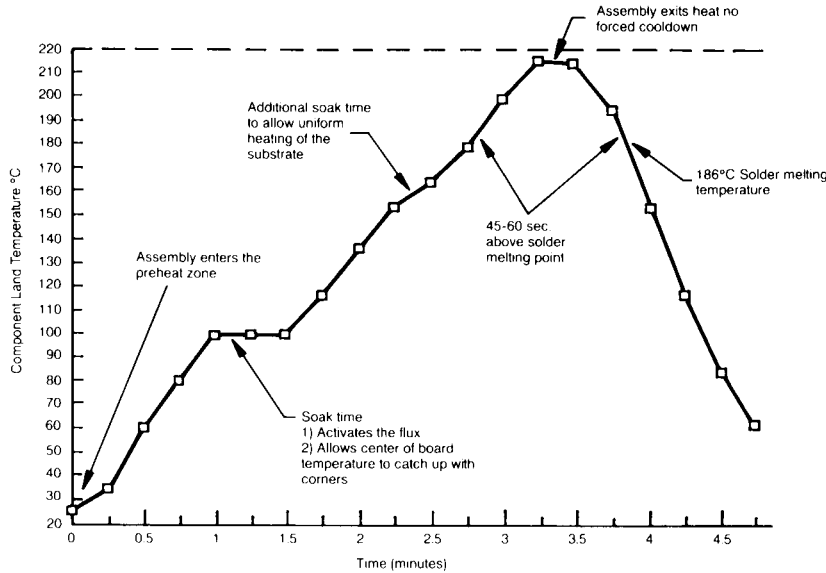

Recommended Ramp Rate Less than 2°C/sec.

WAVE SOLDERING

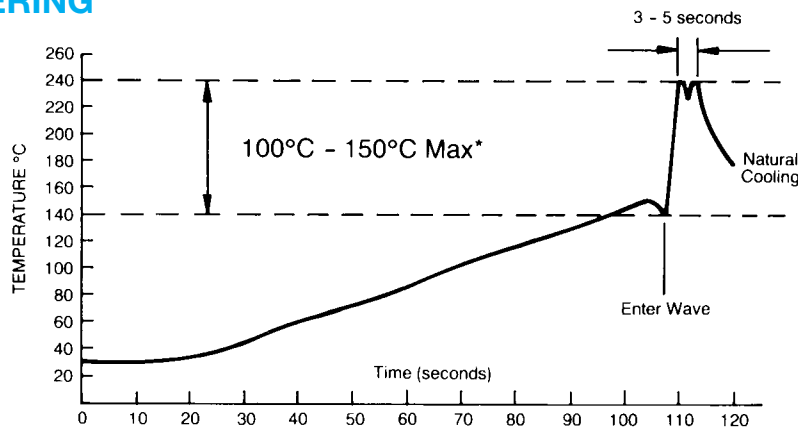

*See appropriate product specification.

VAPOR PHASE

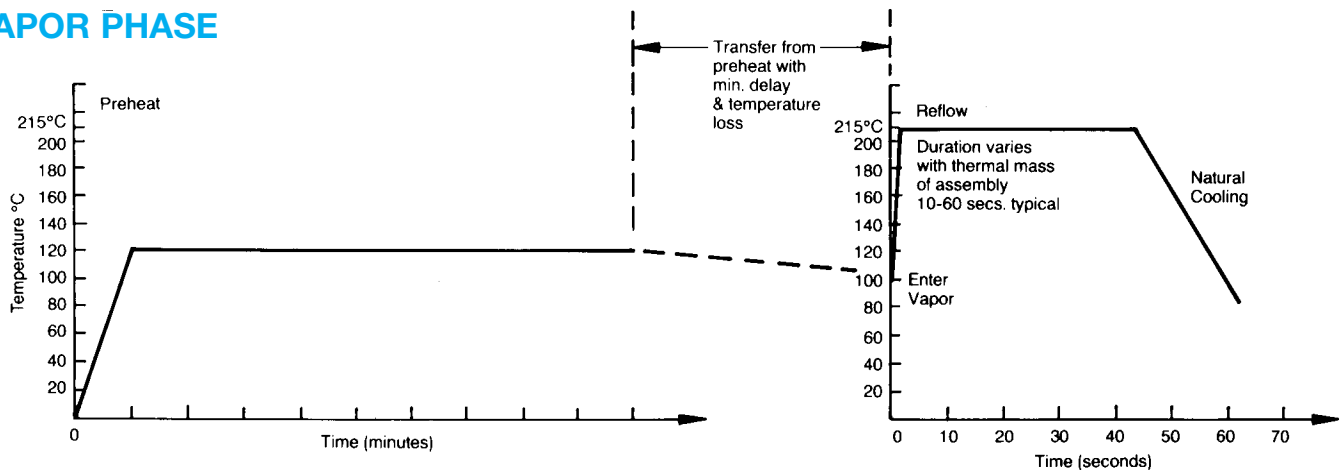

After soldering the assembly should preferably be allowed to cool naturally. In the event that assisted cooling is used, the rate of change in temperature should not exceed that used in reflow.

Technical Summary and Application Guidelines



SECTION 5 MECHANICAL AND THERMAL PROPERTIES OF CAPACITORS

5.1 Acceleration

98.1m/s² (10g)

5.2 Vibration Severity

10 to 2000Hz, 0.75mm of 98.1m/s² (10g)

5.3 Shock

Trapezoidal Pulse, 98.1m/s² for 6ms.

5.4 Adhesion to Substrate

IEC 384-3. minimum of 5N.

5.5 Resistance to Substrate Bending

The component has compliant leads which reduces the risk of stress on the capacitor due to substrate bending.

5.6 Soldering Conditions

Dip soldering is permissible provided the solder bath temperature is ≤ 270°C, the solder time < 3 seconds and the circuit board thickness ≥ 1.0mm.

5.7 Installation Instructions

The upper temperature limit (maximum capacitor surface temperature) must not be exceeded even under the most unfavorable conditions when the capacitor is installed. This must be considered particularly when it is positioned near components which radiate heat strongly (e.g. valves and power transistors). Furthermore, care must be taken, when bending the wires, that the bending forces do not strain the capacitor housing.

5.8 Installation Position

No restriction.

5.9 Soldering Instructions

Fluxes containing acids must not be used.

5.9.1 Guidelines for Surface Mount Footprints

Component footprint and reflow pad design for AVX capacitors.

The component footprint is defined as the maximum board area taken up by the terminators. The footprint dimensions are given by A, B, C and D in the diagram, which corresponds to W, max., A max., S min. and L max. for the component. The footprint is symmetric about the center lines.

The dimensions x, y and z should be kept to a minimum to reduce rotational tendencies while allowing for visual inspection of the component and its solder fillet.

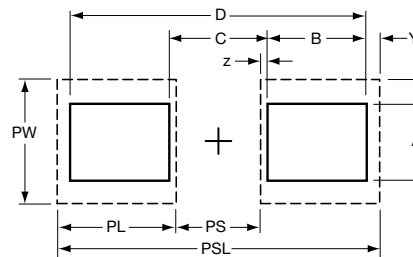

Dimensions PS (Pad Separation) and PW (Pad Width) are calculated using dimensions x and z. Dimension y may vary, depending on whether reflow or wave soldering is to be performed.

For reflow soldering, dimensions PL (Pad Length), PW (Pad Width), and PSL (Pad Set Length) have been calculated. For wave soldering the pad width (PWw) is reduced to less than the termination width to minimize the amount of solder pick up while ensuring that a good joint can be produced.

NOTE: These recommendations (also in compliance with EIA) are guidelines only. With care and control, smaller footprints may be considered for reflow soldering.

Nominal footprint and pad dimensions for each case size are given in the following tables:

PAD DIMENSIONS: millimeters (inches)

| CASE | | PSL | PL | PS | PW | PWw |
|------|---|-------------|-------------|-------------|-------------|-------------|
| TAJ | A | 4.0 (0.157) | 1.4 (0.054) | 1.2 (0.047) | 1.8 (0.071) | 0.9 (0.035) |
| | B | 4.0 (0.157) | 1.4 (0.054) | 1.2 (0.047) | 2.8 (0.110) | 1.6 (0.063) |
| | C | 6.5 (0.056) | 2.0 (0.079) | 2.5 (0.098) | 2.8 (0.110) | 1.6 (0.063) |
| | D | 8.0 (0.315) | 2.0 (0.079) | 4.0 (0.157) | 3.0 (0.119) | 1.7 (0.068) |
| | V | 8.3 (0.325) | 2.3 (0.090) | 3.7 (0.145) | 6.2 (0.245) | 1.7 (0.068) |
| | E | 8.0 (0.315) | 2.0 (0.079) | 4.0 (0.157) | 3.0 (0.119) | 1.7 (0.068) |
| | R | 2.7 (0.100) | 1.0 (0.040) | 1.0 (0.040) | 1.6 (0.060) | 0.8 (0.030) |
| | S | 4.0 (0.160) | 1.4 (0.050) | 1.0 (0.040) | 1.8 (0.070) | 0.8 (0.030) |
| TAC | T | 4.0 (0.160) | 1.4 (0.050) | 1.0 (0.040) | 2.8 (0.110) | 0.8 (0.030) |
| | L | 2.4 (0.095) | 0.7 (0.027) | 0.9 (0.035) | 1.0 (0.039) | - |
| TAZ | R | 3.0 (0.120) | 0.7 (0.027) | 1.6 (0.063) | 1.5 (0.059) | - |
| | A | 3.3 (0.126) | 1.4 (0.054) | 0.5 (0.020) | 2.5 (0.098) | 1.0 (0.039) |
| | B | 4.5 (0.178) | 1.4 (0.054) | 1.8 (0.070) | 2.5 (0.098) | 1.0 (0.039) |
| | D | 4.5 (0.178) | 1.4 (0.054) | 1.8 (0.070) | 3.6 (0.143) | 2.0 (0.079) |
| | E | 5.8 (0.228) | 1.4 (0.054) | 3.0 (0.120) | 3.6 (0.143) | 2.2 (0.085) |
| | F | 6.3 (0.248) | 1.4 (0.054) | 3.6 (0.140) | 4.5 (0.178) | 3.0 (0.119) |
| | G | 7.4 (0.293) | 1.9 (0.074) | 3.7 (0.145) | 4.0 (0.157) | 2.4 (0.095) |
| | H | 8.0 (0.313) | 1.9 (0.074) | 4.2 (0.165) | 5.0 (0.197) | 3.4 (0.135) |

SECTION 6 EPOXY FLAMMABILITY

| EPOXY | UL RATING | OXYGEN INDEX |
|-------|-----------|--------------|
| TAJ | UL94 V-0 | 35% |
| TPS | UL94 V-0 | 35% |
| TAZ | UL94 V-0 | 35% |

SECTION 7 QUALIFICATION APPROVAL STATUS

| DESCRIPTION | STYLE | SPECIFICATION |
|--------------------------|-------|---|
| Surface mount capacitors | TAJ | CECC 30801 - 005 Issue 2 CECC 30801 - 011 Issue 1 MIL-C-55365/8 (CWR11) |
| | TAZ | MIL-C-55365/4 (CWR09) |

TAC, TAJ & TPS Series



Tape and Reel Packaging

Tape and reel packaging for automatic component placement.
Please enter required Suffix on order. Bulk product is not available.

TAC, TAJ AND TPS TAPING SUFFIX TABLE

| Case Size reference | Tape width mm | P mm | 103mm Suffix | (4") reel Qty. | 180mm Suffix | (7") reel Qty. | 330mm Suffix | (13") reel Qty. |
|---------------------|---------------|------|--------------|----------------|--------------|----------------|--------------|-----------------|
| A | 8 | 4 | | | R | 2000 | S | 8000 |
| B | 8 | 4 | | | R | 2000 | S | 8000 |
| C | 12 | 8 | | | R | 500 | S | 3000 |
| D | 12 | 8 | | | R | 500 | S | 2500 |
| E | 12 | 8 | | | R | 400 | S | 1500 |
| V | 12 | 8 | | | R | 400 | S | 1500 |
| R | 8 | 4 | | | R | 2500 | S | 10000 |
| S | 8 | 4 | | | R | 2500 | S | 10000 |
| T | 8 | 4 | | | R | 2500 | S | 10000 |
| TACL | 8 | 4 | X | 500 | R | 3500 | | |
| TACR | 8 | 4 | X | 500 | R | 2500 | | |

| Total Tape Thickness — K max | | | |
|------------------------------|-------------|-----|-----|
| TAC/TAJ/TPS | | | |
| Case size reference | K | Ao | Bo |
| A | 2.3 (0.090) | 1.9 | 3.5 |
| B | 2.6 (0.102) | 3.1 | 3.8 |
| C | 3.3 (0.130) | 3.7 | 6.9 |
| D | 3.6 (0.142) | 4.8 | 7.6 |
| E | 4.8 (0.189) | 4.5 | 7.5 |
| V | 4.0 (0.156) | 6.4 | 7.6 |
| R | 1.9 (0.075) | 1.7 | 2.5 |
| S | 1.9 (0.075) | 1.9 | 3.5 |
| T | 1.9 (0.075) | 3.1 | 3.8 |
| L | 1.1 (0.043) | 1.1 | 2.0 |

PLASTIC TAPE DIMENSIONS

| Code | 8mm Tape | | 12mm Tape | |
|----------------|----------------------|--------------------------------|----------------------|--------------------------------|
| P* | 4±0.1 or 8±0.1 | (0.157±0.004) (0.315±0.004) | 4±0.1 or 8±0.1 | (0.157±0.004) (0.315±0.004) |
| G | 0.75 min | (0.03 min) | 0.75 min | (0.03 min) |
| F | 3.5±0.05 | (0.138±0.002) | 5.5±0.05 | (0.22±0.002) |
| E | 1.75±0.1 | (0.069±0.004) | 1.75±0.1 | (0.069±0.004) |
| W | 8±0.3 | (0.315±0.012) | 12±0.3 | (0.472±0.012) |
| P ₂ | 2±0.05 | (0.079±0.002) | 2±0.05 | (0.079±0.002) |
| P ₀ | 4±0.1 | (0.157±0.004) | 4±0.1 | (0.157±0.004) |
| D | 1.5±0.1 -0 | (0.059±0.004) (-0) | 1.5±0.1 -0 | (0.059±0.004) (-0) |
| D ₁ | 1.0 min | (0.039 min) | 1.5 min | (0.059 min) |

*See taping suffix tables for actual P dimension (component pitch).

TAPE SPECIFICATION

Tape dimensions comply to EIA RS 481 A

Dimensions A₀ and B₀ of the pocket and the tape thickness, K, are dependent on the component size.

Tape materials do not affect component solderability during storage. Carrier Tape Thickness <0.4mm

Standard Dimensions mm

A: 9.5mm (8mm tape)
13.0mm (12mm tape)

Cover Tape Dimensions

Thickness: 75±25µ
Width of tape:
5.5mm + 0.2mm (8mm tape)
9.5mm + 0.2mm (12mm tape)

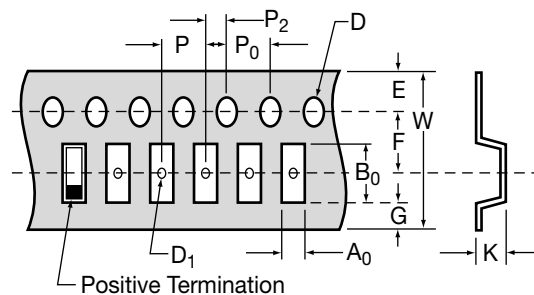

MARKING: TAJ SERIES

For TAJ, the positive end of body has videcon readable polarity bar marking, with the AVX logo “A” as shown in the diagram. Bodies are marked by indelible laser marking on top surface with capacitance value, voltage and date of manufacture. Due to the small size of the A, B, S and T cases, a voltage code is used as shown to the right. R case is an exception in which only the voltage and capacitance values are printed.

| Voltage Code A, B, S and T Cases | Rated Voltage at 85°C |
|-------------------------------------|--------------------------|
| F | 2 |
| G | 4 |
| J | 6.3 |
| A | 10 |
| C | 16 |
| D | 20 |
| E | 25 |
| V | 35 |
| T | 50 |

POLARITY BAR INDICATES ANODE (+) TERMINATION



R Case:

1. Voltage
2. Capacitance in μF



A, B, S and T Case:

1. Voltage Code
(see table)
2. Capacitance in μF
3. Date Code

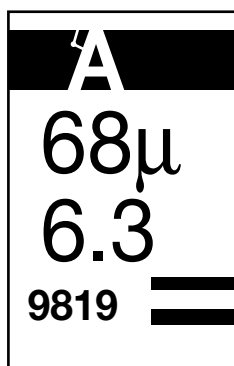

C, D, E and V Case:

1. Capacitance in μF
2. Rated Voltage at 85°C
3. Date Code

TAZ, CWR09, CWR11 Series



Tape and Reel Packaging

Solid Tantalum Chip TAZ Tape and reel packaging for automatic component placement.

Please enter required Suffix on order. Bulk packaging is standard.

TAZ TAPING SUFFIX TABLE

| Case Size reference | Tape width mm | P mm | 7" (180mm) reel | | 13" reel (330mm) reel | |
|---------------------|---------------|------|-----------------|------|-----------------------|------|
| | | | Suffix | Qty. | Suffix | Qty. |
| A | 8 | 4 | R | 2500 | S | 9000 |
| B | 12 | 4 | R | 2500 | S | 9000 |
| D | 12 | 4 | R | 2500 | S | 8000 |
| E | 12 | 4 | R | 2500 | S | 8000 |
| F | 12 | 8 | R | 1000 | S | 3000 |
| G | 12 | 8 | R | 500 | S | 2500 |
| H | 12 | 8 | R | 500 | S | 2500 |

| Total Tape Thickness — K max | |
|------------------------------|--------------------------|
| Case size reference | Millimeters (Inches) DIM |
| A | 2.0 (0.079) |
| B | 4.0 (0.157) |
| D | 4.0 (0.157) |
| E | 4.0 (0.157) |
| F | 4.0 (0.157) |
| G | 4.0 (0.157) |
| H | 4.0 (0.157) |

| Code | 8mm Tape | | 12mm Tape | |
|----------------|----------------------|--------------------------------|----------------------|--------------------------------|
| P* | 4±0.1 or 8±0.1 | (0.157±0.004) (0.315±0.004) | 4±0.1 or 8±0.1 | (0.157±0.004) (0.315±0.004) |
| G | 0.75 min | (0.03 min) | 0.75 min | (0.03 min) |
| F | 3.5±0.05 | (0.138±0.002) | 5.5±0.05 | (0.22±0.002) |
| E | 1.75±0.1 | (0.069±0.004) | 1.75±0.1 | (0.069±0.004) |
| W | 8±0.3 | (0.315±0.012) | 12±0.3 | (0.472±0.012) |
| P ₂ | 2±0.05 | (0.079±0.002) | 2±0.05 | (0.079±0.002) |
| P ₀ | 4±0.1 | (0.157±0.004) | 4±0.1 | (0.157±0.004) |
| D | 1.5±0.1 -0 | (0.059±0.004) (-0) | 1.5±0.1 -0 | (0.059±0.004) (-0) |
| D ₁ | 1.0 min | (0.039 min) | 1.5 min | (0.059 min) |

*See taping suffix tables for actual P dimension (component pitch).

TAPE SPECIFICATION

Tape dimensions comply to EIA RS 481 A

Dimensions A₀ and B₀ of the pocket and the tape thickness, K, are dependent on the component size.

Tape materials do not affect component solderability during storage.

Carrier Tape Thickness <0.4mm

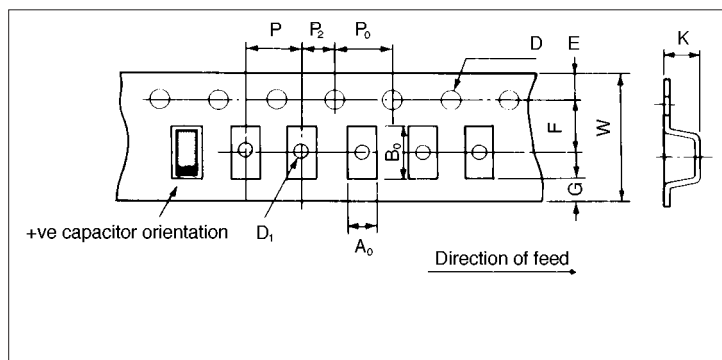

TAZ, CWR09, CWR11 Series



Tape and Reel Packaging

PLASTIC TAPE REEL DIMENSIONS

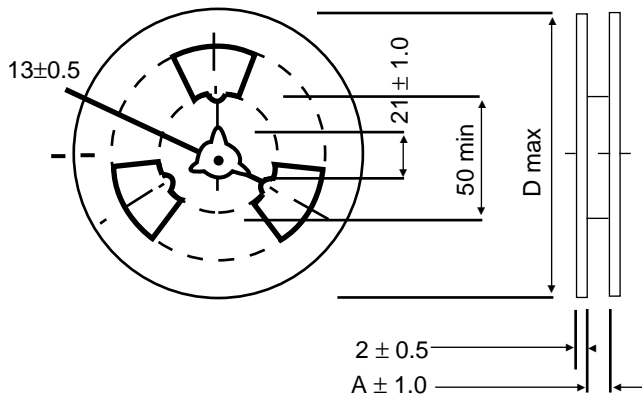

Standard Dimensions mm

A: 9.5mm (8mm tape)
13.0mm (12mm tape)

Cover Tape Dimensions

Thickness: 75±25μ
Width of tape:
5.5mm + 0.2mm (8mm tape)
9.5mm + 0.2mm (12mm tape)

Waffle Packaging - 2" x 2" hard plastic waffle trays. To order Waffle packaging use a "W" in part numbers packaging position.

| Case Size | Maximum Quantity Per Waffle |
|-----------|-----------------------------|
| TAZ A | 160 |
| TAZ B | 112 |
| TAZ D | 88 |
| TAZ E | 60 |
| TAZ F | 48 |
| TAZ G | 50 |
| TAZ H | 28 |
| CWR11 A | 96 |
| CWR11 B | 72 |
| CWR11 C | 54 |
| CWR11 D | 28 |

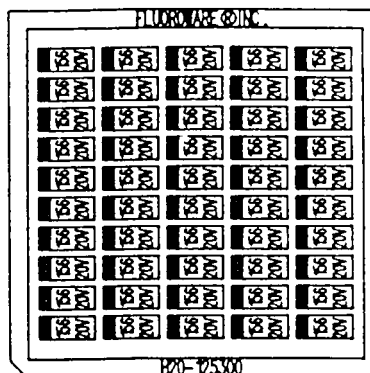

NOTE: Orientation of parts in waffle packs varies by case size.

Some commonly asked questions regarding Tantalum Capacitors:

Question: If I use several tantalum capacitors in serial/parallel combinations, how can I ensure equal current and voltage sharing?

Answer: Connecting two or more capacitors in series and parallel combinations allows almost any value and rating to be constructed for use in an application. For example, a capacitance of more than 60 μ F is required in a circuit for stable operation. The working voltage rail is 24 volts dc with a superimposed ripple of 1.5 volts at 120 Hz.

The maximum voltage seen by the capacitor is $V_{dc} + V_{ac}=25.5V$

Applying the 50% derating rule tells us that a 50V capacitor is required.

Connecting two 25V rated capacitors in series will give the required capacitance voltage rating, but the

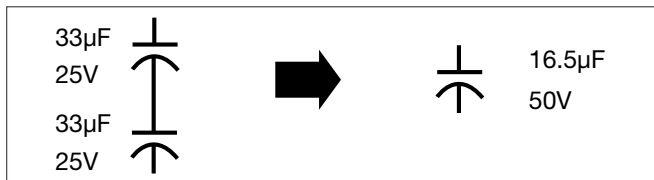

effective capacitance will be halved, so for greater than 60 μ F, four such series combinations are required, as shown.

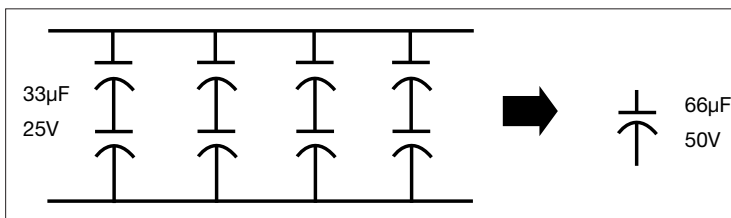

In order to ensure reliable operation, the capacitors should be connected as shown below to allow current sharing of the ac noise and ripple signals. This prevents any one capacitor heating more than its neighbors and thus being the weak link in the chain.

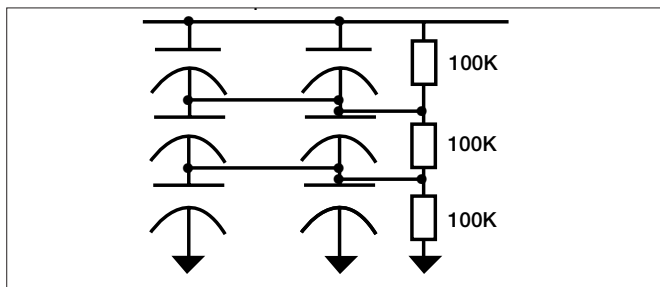

The two resistors are used to ensure that the leakage currents of the capacitors does not affect the circuit reliability, by ensuring that all the capacitors have half the working voltage across them.

Question: What are the advantages of tantalum over other capacitor technologies?

Answer:

1. Tantalum capacitors have high volumetric efficiency.
2. Electrical performance over temperature is very stable.
3. They have a wide operating temperature range -55 degrees C to +125 degrees C.
4. They have better frequency characteristics than aluminum electrolytics.
5. No wear out mechanism. Because of their construction, solid tantalum capacitors do not degrade in performance or reliability over time.

Question: How does TPS differ from your standard product?

Answer: TPS has been designed from the initial anode production stages for power supply applications. Special manufacturing processes provide the most robust capacitor dielectric by maximizing the volumetric efficiency of the package. After manufacturing, parts are conditioned by being subjected to elevated temperature overvoltage burn in applied for a minimum of two hours. Parts are monitored on a 100% basis for their direct current leakage performance at elevated temperatures. Parts are then subjected to a low impedance current surge. This current surge is performed on a 100% basis with each capacitor individually monitored. At this stage, the capacitor undergoes 100% test for capacitance, Dissipation Factor, leakage current, and 100 KHz ESR to TPS requirements.

Question: If the part is rated as a 25 volt part and you have current surged it, why can't I use it at 25 volts in a low impedance circuit?

Answer: The high volumetric efficiency obtained using tantalum technology is accomplished by using an extremely thin film of tantalum pentoxide as the dielectric. Even an application of the relatively low voltage of 25 volts will produce a large field strength as seen by the dielectric. As a result of this, derating has a significant impact on reliability as described under the reliability section. The following example uses a 22 microfarad capacitor rated at 25 volts to illustrate the point. The equation for determining the amount of surface area for a capacitor is as follows:

$$C = (\epsilon (\epsilon_0) (A)) / d$$
$$A = ((C) (d)) / (\epsilon_0 \epsilon)$$
$$A = ((22 \times 10^{-6}) (170 \times 10^{-9})) / ((8.85 \times 10^{-12}) (27))$$
$$A = 0.015 \text{ square meters (150 square centimeters)}$$

Where

C = Capacitance in farads
A = Dielectric (Electrode) Surface Area (m²)
d = Dielectric thickness (Space between dielectric) (m)
ε = Dielectric constant (27 for tantalum)
ε₀ = Dielectric Constant relative to a vacuum
(8.855 × 10⁻¹² Farads × m⁻¹)

To compute the field voltage potential felt by the dielectric we use the following logic.

$$\text{Dielectric formation potential} = \text{Formation Ratio} \times \text{Working Voltage}$$
$$= 4 \times 25$$

$$\text{Formation Potential} = 100 \text{ volts}$$

Dielectric (Ta₂O₅) Thickness (d) is 1.7 × 10⁻⁹ Meters Per Volt

$$d = 0.17 \mu \text{ meters}$$

$$\text{Electric Field Strength} = \text{Working Voltage} / d$$
$$= (25 / 0.17 \mu \text{ meters})$$
$$= 147 \text{ Kilovolts per millimeter}$$
$$= 147 \text{ Megavolts per meter}$$

No matter how pure the raw tantalum powder or the precision of processing, there will always be impurity sites in the dielectric. We attempt to stress these sites in the factory with overvoltage surges, and elevated temperature burn in so that components will fail in the factory and not in your product. Unfortunately, within this large area of tantalum pentoxide, impurity sites will exist in all capacitors. To minimize the possibility of providing enough activation energy for these impurity sites to turn from an amorphous state to a crystalline state that will conduct energy, series resistance and derating is recommended. By reducing the electric field within the anode at these sites, the tantalum capacitor has increased reliability. Tantalums differ from other electrolytics in that charge transients are carried by electronic conduction rather than absorption of ions.

Question: What negative transients can Solid Tantalum Capacitors operate under?

Answer: The reverse voltage ratings are designed to cover exceptional conditions of small level excursions into incorrect polarity. The values quoted are not intended to cover continuous reverse operation. The peak reverse voltage applied to the capacitor must not exceed:

10% of rated DC working voltage to a maximum of 1 volt at 25°C.

3% of rated DC working voltage to a maximum of 0.5 volt at 85°C.

1% of category DC working voltage to a maximum of 0.1 volt at 125°C.

Question: I have read that manufacturers recommend a series resistance of 0.1 ohm per working volt. You suggest we use 1 ohm per volt in a low impedance circuit. Why?

Answer: We are talking about two very different sets of circuit conditions for those recommendations. The 0.1 ohm per volt recommendation is for steady-state conditions. This level of resistance is used as a basis for the series resistance variable in a 1% / 1000 hours 60% confidence level reference. This is what steady-state life tests are based on. The 1 ohm per volt is recommended for dynamic conditions which include current in-rush applications such as inputs to power supply circuits. In many power supply topologies where the di/dt through the capacitor(s) is limited, (such as most implementations of buck (current mode), forward converter, and flyback), the requirement for series resistance is decreased.

Question: How long is the shelf life for a tantalum capacitor?

Answer: Solid tantalum capacitors have no limitation on shelf life. The dielectric is stable and no reformation is required. The only factors that affect future performance of the capacitors would be high humidity conditions and extreme storage temperatures. Solderability of solder coated surfaces may be affected by storage in excess of one year under temperatures greater than 40°C or humidities greater than 80% relative humidity. Terminations should be checked for solderability in the event an oxidation develops on the solder plating.

Question: Do you recommend the use of tantalum capacitors on the input side of DC-DC converters?

Answer: No. Typically the input side of a converter is fed from the voltage sources which are not regulated and are of nominally low impedance. Examples would be Nickel-Metal-Hydride batteries, Nickel-Cadmium batteries, etc., whose internal resistance is typically in the low milliohm range.

1. Steve Warden and John Gill, "Application Guidelines on IR Reflow of Surface Mount Solid Tantalum Capacitors."
2. John Gill, "Glossary of Terms used in the Tantalum Industry."
3. R.W. Franklin, "Over-Heating in Failed Tantalum Capacitors," AVX Ltd.
4. R.W. Franklin, "Upgraded Surge Performance of Tantalum Capacitors," Electronic Engineering 1985
5. R.W. Franklin, "Screening beats surge threat," Electronics Manufacture & Test, June 1985
6. AVX Surface Mounting Guide
7. Ian Salisbury, "Thermal Management of Surface Mounted Tantalum Capacitors," AVX
8. John Gill, "Investigation into the Effects of Connecting Tantalum Capacitors in Series," AVX
9. Ian Salisbury, "Analysis of Fusing Technology for Tantalum Capacitors," AVX-Kyocera Group Company
10. R.W. Franklin, "Analysis of Solid Tantalum Capacitor Leakage Current," AVX Ltd.
11. R.W. Franklin, "An Exploration of Leakage Current," AVX, Ltd.
12. William A. Millman, "Application Specific SMD Tantalum Capacitors," Technical Operations, AVX Ltd.
13. R.W. Franklin, "Capacitance Tolerances for Solid Tantalum Capacitors," AVX Ltd.
14. Arch G. Martin, "Decoupling Basics," AVX Corporation
15. R.W. Franklin, "Equivalent Series Resistance of Tantalum Capacitors," AVX Ltd.
16. John Stroud, "Molded Surface Mount Tantalum Capacitors vs Conformally Coated Capacitors," AVX Corporation, Tantalum Division
17. Chris Reynolds, "Reliability Management of Tantalum Capacitors," AVX Tantalum Corporation
18. R.W. Franklin, "Ripple Rating of Tantalum Chip Capacitors," AVX Ltd.
19. Chris Reynolds, "Setting Standard Sizes for Tantalum Chips," AVX Corporation
20. John Gill, "Surge In Solid Tantalum Capacitors," AVX Ltd.
21. David Mattingly, "Increasing Reliability of SMD Tantalum Capacitors in Low Impedance Applications," AVX Corporation
22. John Gill, "Basic Tantalum Technology," AVX Ltd.
23. Ian Salisbury, "Solder Update Reflow Mounting TACmicrochip Tantalum Capacitor," AVX Ltd.
24. Ian Salisbury, "New Tantalum Capacitor Design for 0603 Size," AVX Ltd.
25. John Gill, "Capacitor Technology Comparison," AVX Ltd.
26. Scott Chiang, "High Performance CPU Capacitor Requirements, how AVX can help," AVX Kyocera Taiwan
27. John Gill and Ian Bishop, "Reverse Voltage Behavior of Solid Tantalum Capacitors."

As the world's broadest line molded tantalum chip supplier, it is our mission to provide **First In Class** Technology, Quality and Service, by establishing progressive design, manufacturing and continuous improvement programs driving toward a single goal:

Total Customer Satisfaction.

Please contact AVX for application engineering assistance.

NOTICE: Specifications are subject to change without notice. Contact your nearest AVX Sales Office for the latest specifications. All statements, information and data given herein are believed to be accurate and reliable, but are presented without guarantee, warranty, or responsibility of any kind, expressed or implied. Statements or suggestions concerning possible use of our products are made without representation or warranty that any such use is free of patent infringement and are not recommendations to infringe any patent. The user should not assume that all safety measures are indicated or that other measures may not be required. Specifications are typical and may not apply to all applications.

Fax Back



For further information and sample availability.

AVX USA: 843-626-5186
 AVX EUROPE: ++44-1252-770004
 AVX ASIA: ++65-3504-880

Name: _____
 Company: _____
 Address: _____
 _____ Zip Code: _____
 Tel. No: _____
 Fax No: _____

Project launch date:

0-3mths 3-6mths 6-12mths >12mths

Circuit Application:

Decoupling Timing Filtering DC Blocking Other

Market Sector:

Telecoms Auto PC Storage Power Supply Industrial
 Cellular Other

Please rank your critical design factors between 1-6 (1 most critical)

Size Max Capacitance Impedance Temperature Stability Leakage Current Height

Please specify any CV ratings required outside of current matrix:

What other SMD products are used in this project:

Ceramic Aluminum Film Chip Arrays Conductive Polymer Os-con

Please specify any non standard special requirements:

Non Std Cap Low ESR Temp Cap Tolerance Interest in specials shown overleaf of Short Form Catalog

Forecast usage of Tantalum:

| | 1998 | 1999 | 2000 |
|-----------------------|----------------------|----------------------|----------------------|
| Standard SMD Tantalum | <input type="text"/> | <input type="text"/> | <input type="text"/> |
| TACmicrochip | <input type="text"/> | <input type="text"/> | <input type="text"/> |

Favored Supplier, Please rank 1-5 (1 most favorable):

AVX Hitachi Kemet NEC Sprague Other

Other engineers in your company who would like information:

Please specify sample requirements:

CAPACITANCE

VOLTAGE



USA

AVX Myrtle Beach, SC Corporate Offices

Tel: 843-448-9411
FAX: 843-448-1943

AVX Northwest, WA

Tel: 360-669-8746
FAX: 360-699-8751

AVX North Central, IN

Tel: 317-848-7153
FAX: 317-844-9314

AVX Northeast, MA

Tel: 508-485-8114
FAX: 508-485-8471

AVX Mid-Pacific, CA

Tel: 408-436-5400
FAX: 408-437-1500

AVX Southwest, AZ

Tel: 602-539-1496
FAX: 602-539-1501

AVX South Central, TX

Tel: 972-669-1223
FAX: 972-669-2090

AVX Southeast, NC

Tel: 919-878-6357
FAX: 919-878-6462

AVX Canada

Tel: 905-564-8959
FAX: 905-564-9728

EUROPE

AVX Limited, England European Headquarters

Tel: ++44 (0)1252 770000
FAX: ++44 (0)1252 770001

AVX S.A., France

Tel: ++33 (1) 69.18.46.00
FAX: ++33 (1) 69.28.73.87

AVX GmbH, Germany - AVX

Tel: ++49 (0) 8131 9004-0
FAX: ++49 (0) 8131 9004-44

AVX GmbH, Germany - Elco

Tel: ++49 (0) 2741 2990
FAX: ++49 (0) 2741 299133

AVX srl, Italy

Tel: ++390 (0)2 614571
FAX: ++390 (0)2 614 2576

AVX sro, Czech Republic

Tel: ++420 (0)467 558340
FAX: ++420 (0)467 558345

ASIA-PACIFIC

AVX/Kyocera, Singapore Asia-Pacific Headquarters

Tel: (65) 258-2833
FAX: (65) 350-4880

AVX/Kyocera, Hong Kong

Tel: (852) 2-363-3303
FAX: (852) 2-765-8185

AVX/Kyocera, Korea

Tel: (82) 2-785-6504
FAX: (82) 2-784-5411

AVX/Kyocera, Taiwan

Tel: (886) 2-2516-7010
FAX: (886) 2-2506-9774

AVX/Kyocera, China

Tel: (86) 21-6249-0314-16
FAX: (86) 21-6249-0313

AVX/Kyocera, Malaysia

Tel: (60) 4-228-1190
FAX: (60) 4-228-1196

Elco, Japan

Tel: 045-943-2906/7
FAX: 045-943-2910

Kyocera, Japan - AVX

Tel: (81) 75-604-3426
FAX: (81) 75-604-3425

Kyocera, Japan - KDP

Tel: (81) 75-604-3424
FAX: (81) 75-604-3425

Contact:



<http://www.avxcorp.com>

S-TSMT10M599-R